



Installation & Maintenance Instructions

Computrac[®] Vapor Pro[®] Rx

Moisture Analyser



Computrac[®] VAPOR PRO[®] Rx

PROPRIETARY RIGHTS NOTICE

The material in this manual contains valuable information developed by Arizona Instrument LLC for use with the Computrac[®] line of moisture analyzers. No part of this manual can be reproduced or transmitted in any form or by any means, electronic, mechanical, or otherwise. This includes photocopying and recording or in connection with any information storage or retrieval system without the express written permission of Arizona Instrument LLC.

ALL RIGHTS RESERVED



© Copyright 2002-2013 Arizona Instrument LLC

PLEASE NOTE: This manual covers both **VAPOR PRO[®] Rx** instrument models: the CT-3500 and the CT-3500-L. Generally, instrument operation and functionality are identical. When there is a difference between the two models, this is specifically delineated in the manual where appropriate. Refer to the instrument serial label to confirm whether your instrument is a CT-3500 or a CT-3500-L.

Table of Contents

1. WARNINGS AND SAFETY INFORMATION	4
2. INTRODUCTION.....	6
3. PRINCIPLES OF OPERATION.....	7
4. UNPACKING.....	8
5. INSTALLATION.....	9
6. CHECK SENSOR STATUS	13
7. DRYNESS TEST.....	14
8. RH SENSOR CALIBRATION CHECK	15
9. RH SENSOR CALIBRATION	17
10. TEMPERATURE CALIBRATION	19
11. RUNNING MOISTURE TESTS	21
Selecting Test Settings	21
Entering Material Name.....	21
Selecting Programmed Test Temperature	22
Selecting Units for the Final Result Display	22
Selecting How to End the Test	22
Selecting Sample Weight Entry Method	23
Selecting Bottle Purge Control.....	24
12. DETERMINING OPTIMUM PARAMETERS	25
13. RUNNING MOISTURE TESTS USING UNSEALED BOTTLES.....	27
RUNNING LYOPHILIZED MOISTURE TESTS	27
14. COMPUTRAC® VAPOR PRO® RX MENU SYSTEM	29
Memory Start Menu	31
Stored Data Menu (Not available on 21 CFR, Part 11 compliant instruments)	31
Calibration Menu.....	32
Setup Menu.....	33
Diagnostic Menu.....	35
15. CONDITION PROMPTS AND SYSTEM FAILURE CODES	36
Condition Prompts.....	36
System Failure Codes.....	37
16. COMMONLY ASKED QUESTIONS.....	38
17. REPAIR AND MAINTENANCE	42
ACCESS COVER REMOVAL.....	42
INSTRUMENT COVER REMOVAL	43
TO INSPECT THE FILTER AND TUBING:.....	43
Q: “How do I change the filter?” Not on all instruments.	44
Q: “How do I Adjust the Dry Air Flow?”	45
18. SPECIFICATIONS AND RATINGS.....	47
19. WARRANTY	48

An updated electronic copy of this manual is available at www.azic.com.

1. WARNINGS AND SAFETY INFORMATION

The VP-Series Moisture Analyzers comply with the Underwriter Laboratories Inc. standards and European Council Directives for Electrical Equipment for Laboratory Use, electromagnetic compatibility, and the stipulated safety requirements. However, improper use or handling of instrument can result in damage to equipment and/or injury to personnel.

The VP-Series Moisture Analyzers are identified as Equipment Class I, Pollution Degree 2, and Installation Category II.

Read this manual thoroughly before using your moisture analyzer to prevent damage to the equipment. Keep these instructions in a safe place. An up-to-date electronic copy of this manual can be obtained by calling AZI Customer Service at 1-602-470-1414 or 1-800-528-7411.

The following instructions will help to ensure safe and trouble-free operation of your moisture analyzer.

- Use the moisture analyzer only for performing moisture analysis of samples. Any improper use of the analyzer can endanger persons and may result in damage to the analyzer or other material assets.
- Do not use this moisture analyzer in a hazardous area/location; operate it only under the ambient conditions specified in these instructions.
- Although the moisture analyzer is simple to operate and is very user friendly, it should only be operated by qualified persons who are familiar with the properties of the sample being analyzed.
- Ensure, before getting started, that the voltage rating printed on the manufacturer's label is identical to your local line voltage, see the section beginning on page 11.
- The VP-Series Moisture Analyzer is provided with a power cord that has a protective grounding conductor. Do not operate the unit without the supplied three-wire power cord or an identical recognized equivalent that meets all applicable standards.
- AZI does not recommend the use of an extension cord. However, if one must be used, use an extension cord that meets all applicable standards and has a protective grounding conductor.
- Do not remove the protective grounding wire from the power supply circuit.
- With the power switch off, power is still applied to the power entry module. Disconnect the power cord from the instrument to ensure complete power removal.
- Position the power cable so that it cannot touch any hot areas of the moisture analyzer.

- Use only AZI supplied accessories and options with VP-Series Moisture Analyzers or check with AZI before using any third party accessories, such as printers and analytical balances, to verify compatibility.
- If there is visible damage to the VP-Series Moisture Analyzer or its power cord, unplug and isolate the unit first and then call Customer Service.
- Do not open the analyzer housing. There are no user serviceable parts or adjustments inside the unit except as listed in this manual. Any maintenance inside the unit is to be performed in strict adherence to the manual procedures or by factory-trained technicians only. Any unauthorized inspection and/or maintenance of the VP-Series Moisture Analyzer will void the warranty.

Prevent excess heat build-up around the analyzer

- When setting up the moisture analyzer, leave enough space to prevent heat from building up and to keep your analyzer from overheating. Leave 20 cm (about 8 inches) around the moisture analyzer and 1 meter (about 3 ft.) above the unit.
- Do not put any flammable substances on, under or near the right side of the moisture analyzer. The area around the Temperature Calibration Interface opening may reach the temperature of the oven.
- Use extreme care when handling the discharged sample bottle. Although the bottles may cool rapidly, they are still very hot when the transport removes them from the oven.

HAZARDS FOR PERSONS OR EQUIPMENT POSED BY USING SPECIFIC SAMPLES: Flammables; explosives; substances that contain flammables, explosives, solvents; and/or substances that release flammable or explosive gases or vapors during the drying process.

- If flammable or explosive liquids are tested, the gasses escaping through the back of the unit are still dangerous when they are exposed to the atmosphere. Fume hoods may offer partial protection but the potential danger will still be present. The user shall be liable and responsible for any damage that arises in connection with the VP-Series Moisture Analyzers and potentially harmful substances.
- Substances containing toxic, caustic or corrosive substances may be analyzed with the unit in an appropriate fume hood only. The fume hood must keep the work area below the lower toxic limit established by appropriate standards.

- Substances that release caustic vapors such as acids should be analyzed in the smallest sample size possible to still achieve satisfactory results. If vapors condense on the VP-Series Moisture Analyzers housing parts, stop the testing, wipe the surface clean with a suitable neutralizer and place the unit in a fume hood capable of removing the vapors. The flow system in the instrument is composed of aluminum and brass fittings connected with clear tubing. Check for compatibility of substances to be tested before inserting them into the instrument.
- The user has the responsibility for carrying out appropriate decontamination if hazardous material is spilt on or inside the VP-Series Moisture Analyzers.

CLEANING

- Clean the VP-Series Moisture Analyzers according to the cleaning instructions only. Use of strong detergents and “oven cleaners” will damage the case and heater housing.
- Before using any cleaning or decontamination method except those recommended by Arizona Instrument, check with AZI Customer Service at 1-602-470-1414 or 1-800-528-7411, to ensure that the proposed method will not damage the equipment.
- The outside housing of the VP-Series Moisture Analyzers should be cleaned with a mild household detergent such as “409” and a soft, lint-free cloth. Paper towels should never be used, as they will scratch the instrument’s finish and the clear lens over the display. If methods that are more stringent are required, call AZI Customer Service at 1-602-470-1414 or 1-800-528-7411 for recommendations.
- Cleaning of the flow system components is normally a factory operation. If components become contaminated, follow the directions contained in this manual beginning on page 42.
- Every precaution has been taken to prevent contaminants from entering the unit. However, if liquids or powders do enter the case, call AZI Customer Service at 1-602-470-1414 or 1-800-528-7411 for recommendations.

The user shall be liable and responsible for any damage that arises in connection with the use this moisture analyzer.

ENVIRONMENTAL CONDITIONS

Storage and Shipping

- Temperature should be between 0 °C to +40 °C (+32 °F to +104 °F).
- Relative Humidity should be between 10% and 80%.

OPERATIONAL CONDITIONS – INDOOR USE.

- Optimum results will be achieved when the unit is set on a smooth, level surface in a non-condensing, non-explosive environment of 0-40° C @ 50% relative humidity and 0-31° C @ 80% relative humidity.
- Do not expose the moisture analyzer unnecessarily to extreme temperatures, moisture, shocks, blows or vibration.

UNPACKING THE MOISTURE ANALYZER

- After unpacking the moisture analyzer, check it immediately for any visible damage as a result of rough handling during shipment.
- Save the box and all parts of the packaging to use when returning your moisture analyzer for calibration. Only the original packaging provides the AZI recommended protection for shipment. Before packing your moisture analyzer for shipment, unplug all connected cables to prevent damage during transit.

WARNING SYMBOLS



- Protective Ground

Identifies the connection on the Chassis and Power Inlet Module for connection of the safety ground (green/yellow) wire.



- Warning

Information or procedure that must be observed.



- Electrical Shock Hazard.

Observe all steps of the procedure to prevent electrical shock.



- Warning, Hot surface or area of possible severe burns.

Use listed precautions when operating the instrument and handling samples to prevent injury.

2. INTRODUCTION

Arizona Instrument is proud to continue its leadership role in developing new technology for the moisture analysis industry. The Computrac[®] **VAPOR PRO[®] Rx** is a giant step forward in the measurement of very low moisture levels.

A revolutionary moisture analyzer with a detection limit of 100 ppm, the Computrac[®] **VAPOR PRO[®] Rx** uses a sensor-based technology and correlates to the Karl Fischer (KF) coulometric titration method (with an oven attachment) in precision and accuracy. The analyzer is simple to operate, minimizes consumables, and does not utilize reagents.

Principles of Operation: The Computrac[®] **VAPOR PRO[®] Rx** heats a sample of test material in a septum bottle. Evolved volatiles are passed to an analysis cell where the moisture content of the flowing gas is measured. A microprocessor integrates the varying moisture signal and converts the signal to micrograms of water for display. Results are available in parts per million, percent moisture, or total micrograms of water. Arizona Instrument's innovative prediction algorithm automatically terminates the test in just minutes when sufficient information is collected to allow accurate determination of the sample's moisture content. The heating range of the Computrac[®] **VAPOR PRO[®] Rx** is 25 °C to 275 °C. Test parameters such as sample size, heater temperature and test ending criteria can be altered to optimize speed and accuracy.

Performance: Designed for lab or production floor use, the Computrac[®] **VAPOR PRO[®] Rx** Moisture Analyzer uses patented, state-of-the-art technology specifically designed to provide accurate and precise results in a timely manner. This ensures that product quality is achieved and maintained.

The Computrac[®] **VAPOR PRO[®] Rx** stores programmed memory settings for up to 102 materials and in instruments that are not 21 CFR, Part 11 compliant, retains the data from the last 30 sample test runs. The software automatically calculates the statistics of any selected stored data upon demand. All retained test data can be automatically sent to an external printer or personal computer at the end of a test or on request.

NIST traceable 1.0 µl capillary tubes, which permit quick and easy system verification, are provided in the accessory kit. System calibration is checked in just minutes. Re-calibration is a menu driven procedure to assure accurate and reliable results day after day. Built-in self-diagnostics constantly monitor system conditions to detect and report any abnormalities in the hardware, software, moisture sensor or flow system.

3. PRINCIPLES of OPERATION

The Computrac[®] VAPOR PRO[®] Rx utilizes a cylinder shaped bottle heater, a dry air-carrier gas flow system and a moisture sensor. The instrument heats a sample of test material contained in a 20 ml septum bottle or sealed freeze dried container. Volatiles, driven off from the sample, are carried by the air system through the sensor block containing the Relative Humidity (RH) sensor. The RH sensor used to detect water in the gas stream is a polymer capacitor relative humidity sensor. The reading from this sensor is combined with sensor block temperature and carrier gas flow data in a microprocessor to generate an accurate measurement of the moisture content in the sample. The instrument then displays the result in terms of:

- Parts per million (ppm) H₂O,
- Micrograms (μg) H₂O, or
- Percentage (%) H₂O.

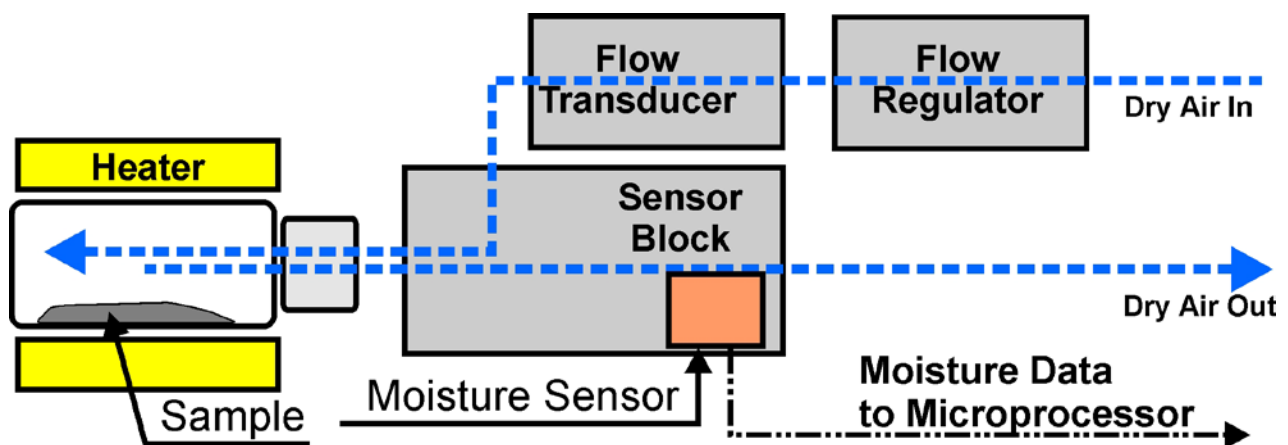

Computrac[®] VAPOR PRO[®] Rx Basic Flow System

Test parameters such as temperature, ending criteria, and purge time can be changed to optimize test speed and accuracy. See Appendix A, beginning on page 47, for detailed specifications and operating limits.

4. UNPACKING

Unpack the instrument and locate the following items:

Computrac [®] VAPOR PRO [®] Rx (CT-3500 or CT-3500-L)		AZI Part Number		
		CT 3500-L or CT-3500-L-100V	CT 3500L-220V differences	
Accessory Kit		Y990-0151		
1	Power Cord (varies with area)	200-0002 USA/Canada	200-0003 England	200-0008 Europe
3'	Clear Tubing, 1/8" X 1/4"	345-0050		
1	Tweezers	690-0012		
1	User's Manual	700-0050		
60	Septa, Sample Bottle	990-0074		
10	Sample Bottles, 20ml	990-0153		
1	Sample Breaker	990-0154		
1 Vial	1.0 ml Microcap, 100/Vial	990-0150		
1	Inline Desiccator Kit	Y990-0116		
1	Vapor Pro [®] Hydrophobic Filter Kit	Y990-0155		

Optional Accessories:

Hydrophobic Filter	990-0059
101 key PC keyboard	990-0088
Travel case	990-0092
Digital balance with cable and Communications Software	Y990-0082
PC graphics printer kit	Y990-0098
Mini Printer kit	Y990-0120
Temperature Calibration Kit with 9 VDC, 100 mA, 3.5 mm male plug, + tip, DC Adaptor	Y990-0142 (110 VAC) Y990-0165 (220 VAC)
Dry Air Generator kit (110 VAC)	Y990-0143
Needle Replacement Kit	Y990-0161
IQOQPQ Validation Package	Y990-0164
Vapor Pro [®] Communications Package	Y990-0196

If you are unable to locate any of the standard items or have questions regarding the optional accessories, contact AZI Customer Service at (800) 528-7411 or (602) 470-1414.

5. INSTALLATION

Place the Computrac® **VAPOR PRO® Rx** on a solid level surface that is large enough to accommodate the instrument and any accessories or materials that may be required for your work (balance, printer, sample bottles, samples, etc.).

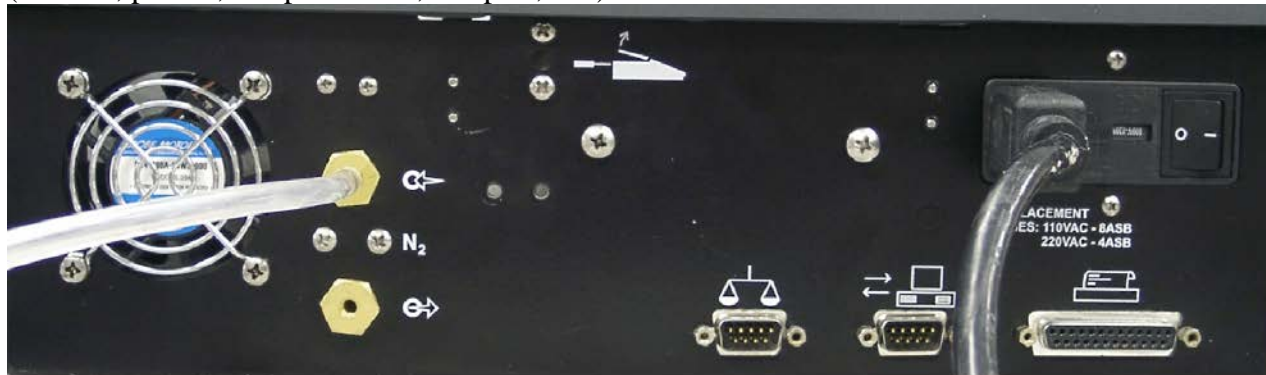

**Dry Air Inlet with
AZI clear tubing
connected**

**AC Power entry module with
ON/OFF Switch showing
power cord connected.**

Using 1/8" ID clear tubing [AZI P/N 345-0050], attach a dry nitrogen or dry carrier gas source to the **Dry Air Inlet Port** fitting on the back of the instrument, indicated by an arrow pointing to the connector.

- Carrier gas source may be a cylinder, facility air or nitrogen supply, or dry air generator.
- The pressure from the compressed gas cylinder is very high and is normally reduced by a two-stage regulator. The pressure from the compressed air or nitrogen system in most facilities will be at moderate pressure and normally require only a single-stage regulator. The dry air generator, manufactured by Arizona Instrument LLC, P/N Y990-0143, produces the pressure required by the instrument and therefore, no additional regulator is need. This is the ideal choice for portable operation.
- Examples of regulators capable of regulating pressure to 30 psi follow.
 - For cylinder applications:
 - ◆ Multi-stage Gas Regulator for Compressed Air Cylinder, VWR #55850-474 or equivalent.
 - For supplied gas sources:
 - ◆ Matheson Gas Products Model 3473 Single Stage Line Regulator or equivalent.
- Connecting tubing must be AZI P/N 345-0050 clear impermeable tubing, unless otherwise indicated, to prevent introducing moisture into the carrier gas system. Tubing size is 1/8" ID X 1/4" OD.
- A desiccant bed is recommended to remove any moisture that may be present in the carrier gas supply. A desiccant kit is available from AZI as Kit, Desiccator, Inline P/N Y990-0116. As illustrated below, the desiccant is placed just before the inlet connection of the instrument. The desiccant turns from blue to pink as it absorbs moisture. When the entire column of desiccant is pink, it will no longer absorb moisture, and the desiccant must be replaced or regenerated to restore the drying capacity.

- Instructions on the Drierite® website tell how to regenerate the Drierite® for continued use. For further information, contact W.A. Hammond Drierite Co Ltd at (937) 376-2927 or at www.drierite.com.

The following diagrams are not to scale but illustrate the preferred connecting arrangements. For all but the dry air generator, adjust the pressure to the instrument between 17 and 22 psi (118-152 kPa) with 20 psi (138 kPa) preferred.

Cylinder with two-stage regulator is connected to the desiccator with clear tubing [AZI P/N 345-0050]. The desiccator is connected to the instrument with the same type of tubing. Pressure to the instrument is set between 17 and 22 psi (118-152 kPa).

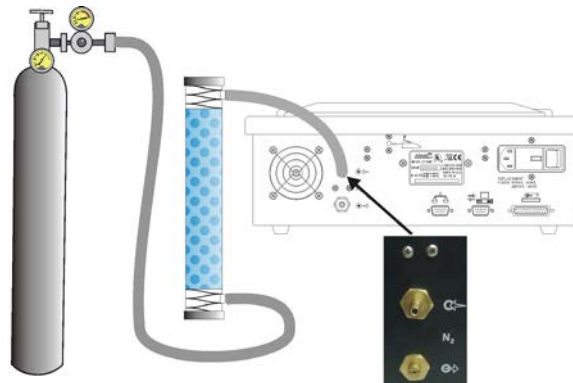

Compressed Gas Cylinder

The facilities air or gas supply is usually connected to a wall or bench mounted regulator. The regulator is connected to the desiccator with clear tubing [AZI P/N 345-0050]. The desiccator is connected to the instrument with the same type of tubing. Pressure to the instrument is set between 17 and 22 psi (118-152 kPa).

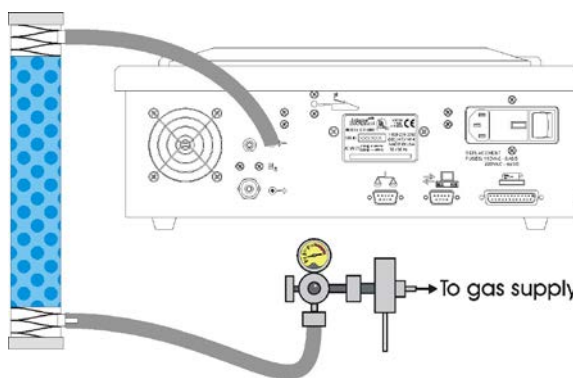

Facility Air or Gas Supply

The dry air generator is connected to the desiccator with yellow tubing [AZI P/N 2500 3003]. The desiccator is connected to the instrument with clear tubing [AZI P/N 345-0050]. Pressure from the Dry Air Generator cannot be adjusted but should be above 14.5 psi (100 kPa).

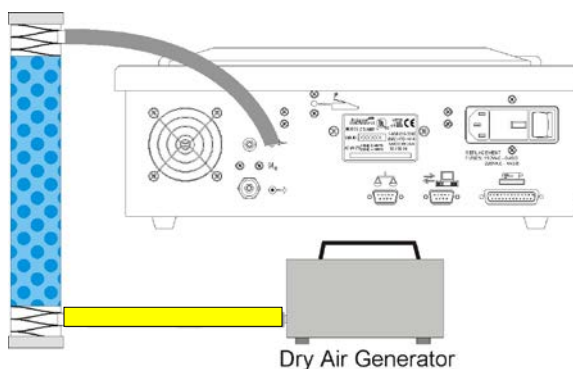

Dry Air Generator

For all but the dry air generator, adjust the pressure to the instrument so that it is set between 17 and 22 psi (118-152 kPa) with 20 psi (138 kPa) being the preferred pressure.

If you plan to use a printer, electronic balance, and/or computer, connect them to the marked connectors at the back of the instrument. The accessory keyboard connects to a fitting on the side nearest the printer connector of the instrument. Connect all accessories while the instrument is turned OFF, and power ON the accessories before powering ON the instrument.

Power control and fuses are located at the rear of unit.

The power entry module must be configured for the voltage supplied to it. This will be either 100 to 120 VAC or 220 to 240 VAC. The unit is configured at the factory for the destination country at time of shipment. However, to ensure the unit is configured correctly, verify the arrow indicator on the fuse holder points to the proper voltage for your environment before connecting to a power source.



Voltage Indicator Arrow

To change from 110 to 220VAC or from 220 to 110VAC:

- Ensure the power switch, located next to the fuse holder, is in the off (O) position.
- Remove the fuse holder from the power entry module by prying with a small flat screwdriver.
- Change the fuse:
 - A unit operating from 100-120 VAC should have two 8-amp slow blow fuses, (AZI P/N 190-1001).
 - A unit operating from 200-240 VAC should have two 4-amp slow blow fuses, (AZI P/N 190-1002).
- Turn the fuse holder around, and slide it back in so that the arrow indicator on the power entry module is pointing to the correct voltage for your environment.

CAUTION



Never use any power cable other than the one provided or one of equivalent UL listed ratings. Be sure that the ground pin of the power source is properly grounded. Never cover the power receptacle so that the power cord cannot be removed quickly and easily.



Connect the instrument line cord into the matching port on the back of the instrument.

Connect the plug end of the cord into a dedicated 15 Amp line source of the voltage for which the power entry module is set. (100 to 120 VAC or 220 to 240 VAC)

Toggle the power switch at the rear of the unit to the ON (I) position.

After a quick view of the instrument identification and the firmware version, the Main Test Screen will appear.

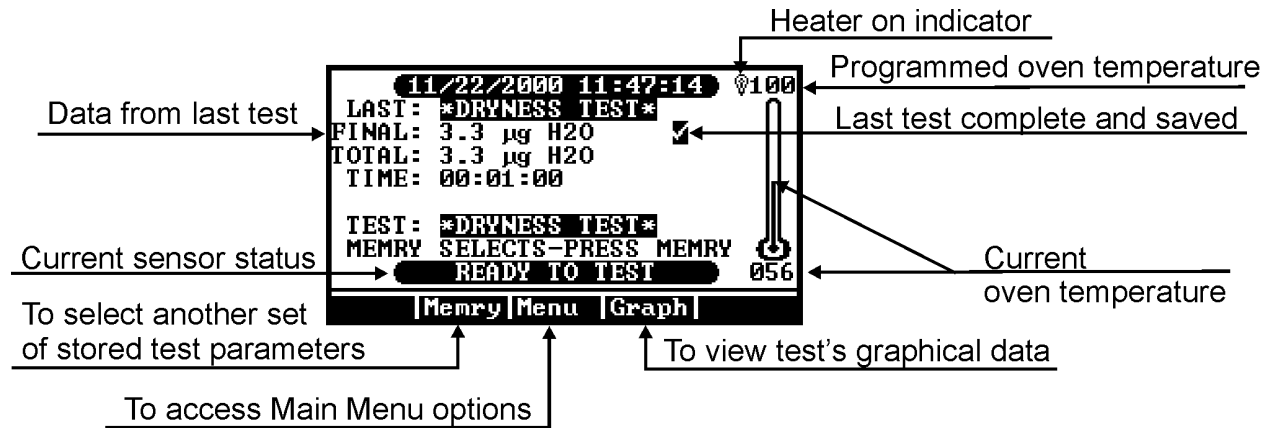

Allow the instrument to warm up for 20 minutes.

6. CHECK SENSOR STATUS

The display shows the function of the soft-keys at the bottom of the screen. Use the soft-key buttons below the display on the front panel to move through the menu screens and system settings. The function of each soft key will change as needed to provide the selection and input requirements of each menu screen.

From the Main Test Screen, press **[Menu]** to reveal the **Main Menu**.



Move the cursor down to highlight the **Diagnostic Menu**.

Press **[Selct]**.

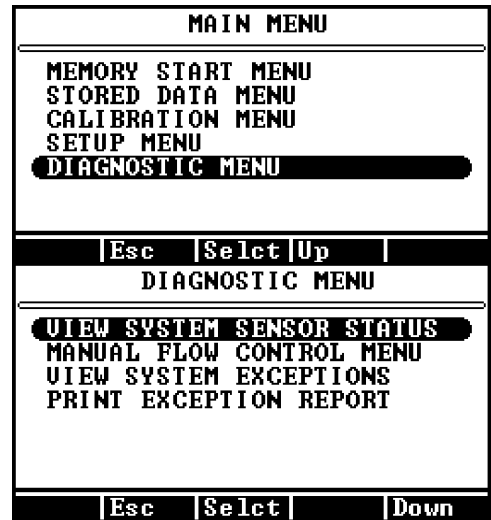

Verify that the **View System Sensor Status** option is highlighted.

Press **[Selct]** again to view the Sensor Status Screen.

If the FLOW IN is not 75 ± 2 milliliters per minute (mL/min) on a CT-3500-L or 100 ± 10 mL/min on a CT-3500, go to “How do I Adjust the Dry Air Flow?” on page 45.

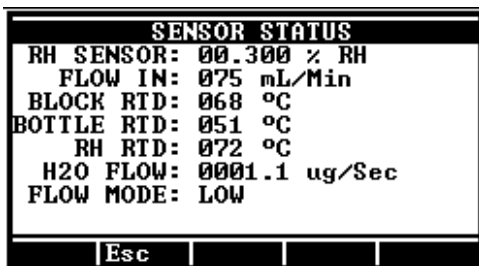

CT-3500-L

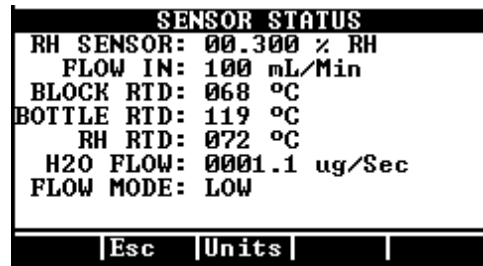

CT-3500

Return to the Main Test Screen by pressing **[Esc]** three times.

7. DRYNESS TEST

For all tests using a bottle, ENSURE the slick Teflon[®] side of the septum is to the inside of the bottle or the moisture trapped in the septum will cause false moisture indications.

When the display on the Main Test Screen indicates “Ready to Test”:

- Press [Memry]
- Then select *DRYNESS TEST*

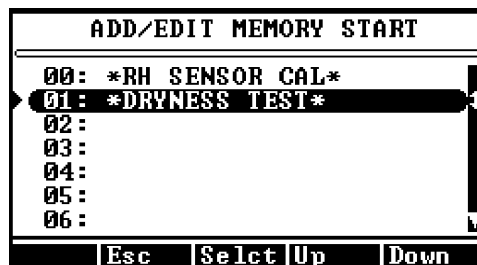

Press [START].

- This test will run for two (2) minutes to test for moisture that may have migrated into the system.
- If this is the first test after changing a portion of the flow system; tubing, needle, filter, etc., or if the result is more than 5 µg, repeat the Dryness Test up to four (4) times.
- If the result does not fall under 5 µg after the 4th test:
 - Check for moisture in the dry air supply line.
 - Check and/or change the hydrophobic filter, see page 44.
 - Call AZI Customer Service at (800) 528-7411 or (602) 470-1414.

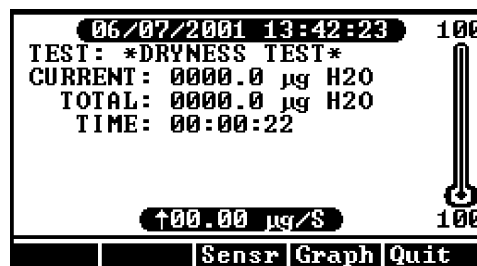

8. RH SENSOR CALIBRATION CHECK

The water calibration test verifies that the instrument is working properly. This test only takes a few minutes. Arizona Instrument recommends that this test be run every day to verify the system's calibration and accuracy. For greatest accuracy, each test should be run with new septa. Ensure the septum is installed with the smooth, shiny, Teflon[®] liner to the inside of the bottle to prevent moisture from the soft plastic from affecting the result.

Carefully remove a 1.0 µl Microcap, AZI P/N 990-0150 from the storage bottle. Use tweezers to handle the tube.

Just touch the end of the tube into purified or de-ionized water. The tube must be in contact with the water long enough to fill, about 10 to 15 seconds. If the tube is not full, the reading will be low.

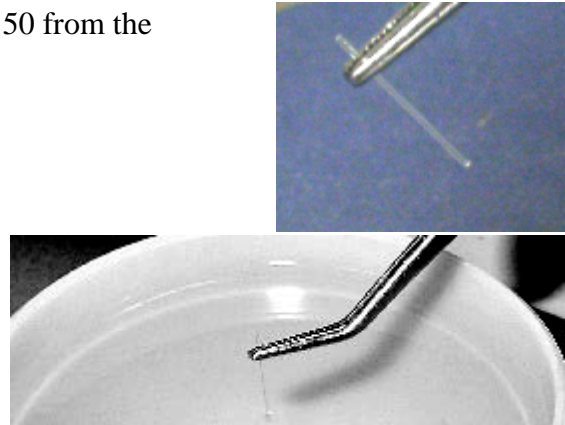

Pull the capillary tube straight up out of the water. A rapid but straight motion will tend to remove excess water from the side of the tube. Excess moisture on the side of the tube will cause a high reading.

Visually verify that no free water is on the outside of the tube. Wipe the tube only if necessary with a finger or other non-absorbent instrument. **DO NOT WIPE THE TUBE WITH A TISSUE OR OTHER OBJECT THAT WILL SOAK WATER OUT OF THE CAPILLARY TUBE.**

Gently place the tube into a dry sample bottle just past the bottle's neck as shown. Dropping or shaking the tube will cause water to be lost and will give erratic readings over several tests.



Install a dry cap and septum on the sample bottle with the smooth, shiny side of the septum to the inside of the bottle.

Gently place the sample bottle onto the transport so that the tube rests toward the neck of the bottle as shown.



When “READY TO TEST” is displayed on the Main Test Screen:

- Press [**Memry**]
- Highlight *RH SENSOR CAL*
- Press [**START**]

Accuracy of results should be within five (5) percent of the capillary capacity, usually 1000 micrograms (950 to 1050 µg). If using a different value capillary tube, use ±5% of the value listed on the container for the tolerance.

Allow the test to proceed until completed. It should take five to seven (5 to 7) minutes.

If desired, perform four more calibration tests and calculate the statistics. Calculations must be performed by hand if the instrument is 21 CFR, Part 11 compliant.

After the 5th test:

- Press [**Menu**] for the MAIN MENU,
- Highlight STORED DATA MENU and press [**Select**], (Not available in 21 CFR. Part 11 compliant instruments)
- Highlight ANALYZE STORED DATA and press [**Select**],
- Highlight and [**Select**] the desired results to be included in the statistics, and
- Press [**Stat**] to calculate Average, Standard Deviation, and Coefficient of Variation.
 - The average should fall within ±5% of the capillary tube’s calibrated value.
 - If the mean result does not fall within the ±5% range, perform the sensor calibration. See the procedure beginning on page 17.

If this is a 21 CFR, Part 11 compliant instrument, all readings must be recorded by hand; AZI recommends using a printer to capture the values. The calculations must be performed on a calculator since the instrument’s storage and analysis functions are disabled.

Mean, Standard Deviation, and Coefficient of Variation are calculated using the following formulas.

- Mean = total of results divided by number of results.
- Standard Deviation = $\sqrt{\frac{\sum(\bar{x} - x)^2}{n - 1}}$
- Coefficient of Variation = Standard Deviation divided by Mean times 100%

9. RH Sensor Calibration

The Relative Humidity Sensor is calibrated using the same technique as for the calibration check. The difference is in what happens to the results. The calibration calculation may be used to calibrate the sensor, whereas the check calculation is only for information. Therefore, the first portion of the sensor calibration is like the calibration check.

Some part numbers of items used during the test and calibration are given below for reference.

- Sample Bottle 990-0153
- Septa, Sample Bottle 990-0074
- Capillary Tubes, 1.0 μ l, 100/vial 990-0150

Carefully remove a capillary tube from the storage bottle. Use tweezers to handle the tube.

Just touch the end of the tube into purified or de-ionized water. The tube must be in contact with the water long enough to fill. If the tube is not full, the reading will be low.



Pull the capillary tube straight up out of the water. A rapid but straight motion will tend to remove excess water from the side of the tube. Excess moisture on the side of the tube will cause a high reading.

Visually verify that no free water is on the outside of the tube. Wipe the tube only if necessary with a finger or other non-absorbent instrument. **DO NOT WIPE THE TUBE WITH A TISSUE OR OTHER OBJECT THAT WILL SOAK WATER OUT OF THE CAPILLARY TUBE.**

Gently place the tube into a dry sample bottle just past the bottle's neck as shown. Dropping or shaking the tube will cause water to be lost and will give erratic readings over several tests.



Install a dry cap and septum on the sample bottle with the smooth, shiny side of the septum to the inside of the bottle.

Gently place the sample bottle onto the transport so that the tube rests toward the neck of the bottle as shown.



When “READY TO TEST” is displayed on the Main Test Screen:

- Press [**Memry**],
- Highlight *RH SENSOR CAL*
- Press [**START**]

Allow the test to proceed until completed. It should take five to seven (5 to 7) minutes.

NOTE: At least five (5) tests are required for the proper analysis and correction factors to be calculated.

When the instrument again indicates “READY TO TEST,” prepare and load another capillary tube and sample bottle, and press [**START**] to perform another test. Do this at least four (4) more times, or until you have a total of five valid test results.

To be considered valid, all 5 tests must give results within $\pm 50 \mu\text{g}$ of each other.

If five valid results are not available, repeat the tests until there are five valid tests. If continued testing does not produce five valid test results, please contact Customer Service for assistance at 602-470-1414 or 800-528-7411 or via email at support@azic.com.

When five tests results are available, press [**Menu**] and the Main Menu Screen appears.

- Select **CALIBRATION MENU**.
- Select **PERFORM RH SENSOR CAL**.
- Press [**Selct**], [**Down**], and [**Selct**] to select all calibration tests to be included in the calculations.
- Press [**Cal**]. The screen will display the calibration water mass.
- If necessary, use [**Edit**] to change the value of the capillary tube in grams. $1.0 \mu\text{l} = 1000 \mu\text{g}$, $.5 \mu\text{l} = 500 \mu\text{g}$, and $.1 \mu\text{l} = 100 \mu\text{g}$.
- Press [**Go**]. A screen will appear listing the calculated data and calibration factor.
- Press [**Accpt**] to save the new calibration constant.

The new calibration constant will remain in memory until the next sensor calibration is performed. The RH Sensor Tests used for this calibration will be automatically deleted so they will not be used for the next calibration.

Press the [**Esc**] key until the **Main Test Screen** appears.

Perform at least one more calibration check to verify the accuracy of the calibration.

Accuracy of results should be within five (5) percent of the capillary capacity of 1000 micrograms, or in the range 950 to 1050 μg .

10. TEMPERATURE CALIBRATION

TIP: The temperature calibration and verification take approximately five (5) hours.

Parts Required in addition to the VAPOR PRO® RX

Amt.	AZI Part Number	Description
1	Y990-0142 (110 VAC) Y990-0165 (220 VAC)	Temperature Calibration Kit with 9 VDC, 100 mA, 3.5 mm male plug, positive tip, DC Adaptor
1	Y990-0098 or Y990-0120	Graphics or Mini Printer kit with cable (optional)

Install the Temperature Calibration Probe into the calibration port to the rear of and below the bottle ramp as shown.

The probe must be inserted all the way in until the handle touches the case.

Run the cable behind the instrument as shown to the right to help hold the probe in place.

Plug the probe interface cable into the matching connector on the Temperature Calibration Interface (TCI) box. Plug the RS-232 interface cable into the matching connector on the TCI box and the Balance I/O port on the back of the instrument. Plug the AC adaptor into an appropriate isolated power outlet.

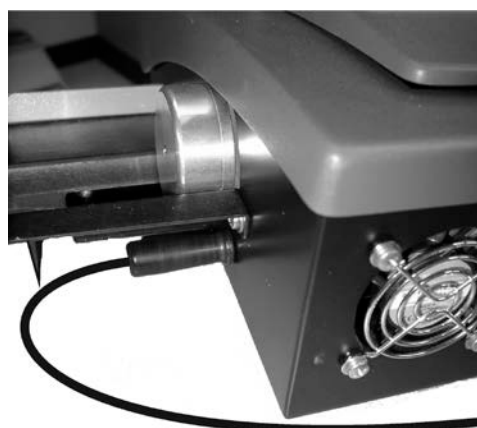

Turn the **VAPOR PRO® Rx** ON. From the Main Test Screen, press **[Menu]** to bring up the MAIN MENU. Press **[Down]** (if necessary) so that CALIBRATION MENU is highlighted - press **[Select]**. At the Calibration Menu, press **[Down]** until TEMPERATURE CALIBRATION is highlighted - press **[Select]**.

Highlight ENTER DEVICE DATA and enter the appropriate data for the interface serial number, probe serial number and calibration/certification date.

- The interface and probe serial numbers and the certification date are located on the temperature calibration interface label (the black box).

ENTER DEVICE DATA	
INTERFACE #:	00123
PROBE #:	04567
CERT DATE:	01/02/2002
<div style="text-align: right;"> [Esc] [Edit] [Down] </div>	

Return to the TEMPERATURE CALIBRATION MENU; highlight VERIFICATION SETUP and press **[Select]**.

- The purpose of the verification function is to confirm whether the calibration was successful or not at a given set of temperatures. The verification process can be run automatically following the calibration by selecting ON at the AUTO-VERIFY prompt.
- The rest of these instructions assume that the verification is being run automatically. (AUTO-VERIFY: ON) If you do not wish to edit the temperatures, press **[Esc]** and move to the next step.

VERIFICATION SETUP	
AUTO VERIFY:	ON
TEMP #1:	000
TEMP #2:	120
TEMP #3:	160
TEMP #4:	200
<div style="text-align: right;"> [Esc] [Edit] [Up] [Down] </div>	

To select which temperature(s) will be verified, press **[Down]** to the TEMP # prompt and press **[Edit]**.

- Using the **[Incr]** and **[Decr]** keys, enter the temperature you wish to verify and press **[Quit]**, then **[Accpt]**. The temperatures selected should be the ones that best represent those used for your product(s). When finished, press **[Esc]**.

Place a bottle with cap and clean septa on the transport.

Highlight RUN TEMP CAL and press **[Select]**. The next screen will ask to ensure that you have the temperature calibration device. If the device is hooked up, press **[Go]**.

When the verification is complete, the screen will display:

- **Verify: Passed or Verify: Failed**
- Key Options of **[Quit]** and **[Go]**

Press **[Go]** to save the data.

If the unit failed at any given point, run the calibration again to improve the results.

If a printer is connected to the instrument, highlight PRINT TEMP CAL REPORT and press **[Select]** to print out the calibration report.

Calibration is complete. Disconnect the calibration interface.

11. RUNNING MOISTURE TESTS

The Computrac® **VAPOR PRO® Rx** has 102 available positions to store test parameters for different materials. Storing the parameters ensures that each test of the same material will use the same parameters to assure accurate, reliable, and repeatable testing.

Selecting Test Settings

- From the **MAIN MENU**:
 - Highlight **MEMORY START MENU**, and
 - Press [**Selct**].

- From the **MEMORY START MENU**:
 - Highlight **ADD/EDIT MEMORY START**,
 - Move the cursor down to an available memory start setting (a blank line), and
 - Press [**Selct**].

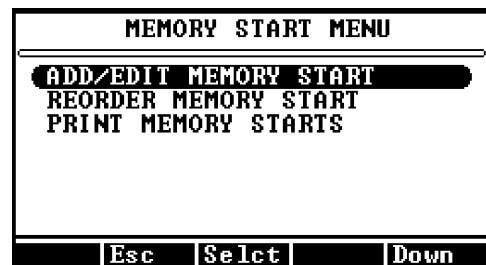

Entering Material Name

- Press [**Selct**] then [**Edit**] at the Edit Sample ID line.
 - Use the [**Left**] and [**Right**] keys to move the cursor's position left and right.
 - Use the [**Incr**] and [**Deer**] keys to scroll through the letters, numbers, and symbols.

TIP: If a keyboard is included with your system, use the arrow keys on the 101-key keyboard to navigate the menu system. Be sure to remove power from the instrument before connecting the keyboard.

The keyboard makes entry of long strings of characters such as product names easy, since all letters, numbers and symbols can be used while editing.

- Enter the name of the material to be tested and then press [**Quit**] followed by [**Accpt**].

Selecting Programmed Test Temperature

- Determining the Test Temperature
 - Generally, use the highest temperature possible without causing other ‘undesirable’ conditions (such as melting or excessive release of other volatiles). The instrument is relatively insensitive to the exact temperature used. Too low a temperature will result in long test times and possibly low results.
 - In most cases, it is important that the sample not melt. A melted sample may form an impermeable skin and trap moisture, producing a low result.
- The following guidelines will help.
 - If you have another moisture determination method (reference method), set the test temperature to the same temperature as used in your reference method.
 - If the melting temperature is known, use a temperature 10 or 20 degrees lower.
- To program test temperatures:
 - Highlight **TEMPERATURES** on the **EDIT MEMORY START MENU**.
 - Press [**Selct**], then [**Edit**].
 - Use the [**Left**] and [**Right**] keys to move the cursor’s position left and right to the digit to be changed.
 - Use the [**Incr**] and [**Decr**] keys to scroll through the numbers
 - When complete, press [**Quit**] followed by [**Accpt**].
- When toggled on, the **COLD START ENABLE** function allows testing to begin at an ambient temperature. During the test, the oven will ramp-up to the pre-programmed temperature. The **COLD START ENABLE** is rarely used.

Selecting Units for the Final Result Display

- Highlight **RESULT DISPLAY OPTION**.
- Press [**Selct**], then [**Edit**].
 - Use the [**Incr**] and [**Decr**] keys to scroll through the options.
- Select either:
 - Percentage (%) of water,
 - Parts per million (ppm) of water, or
 - Micrograms (µg) of water measured.
- Press the [**Quit**], then the [**Accpt**] keys.

Selecting How to End the Test

- Highlight **ENDING CRITERIA**.
- Press [**Selct**].
- Use the [**Up**] and [**Down**] keys to select the type of ending value.
- Press [**Selct**].

RATE: Ends the test when the moisture evolved from the sample drops below the programmed microgram per second value. Use RATE if you want to match an existing standard or method that utilizes RATE criteria (such as the KF titration method). This method is extremely dependent on the amount of sample used and water collected during a test. For repeatability testing, use a very consistent sample size within ± 0.2 gram for each test.

PREDICT: Ends the test when the built-in programmed criteria that mathematically calculate the end point moisture content have been satisfied. Use PREDICT if you want to more accurately determine the actual moisture content or are working independently of other standards or methods. This calculation constantly monitors moisture loss from the sample and extrapolates the final moisture concentration. PREDICT ending criteria provides the quickest test times.

TIME: Ends the test when the programmed testing period has elapsed. Any value from 001 to 999 minutes may be entered. TIME ending is seldom superior to the PREDICT calculation but is useful when:

- Conducting application characterization tests, or
- Investigating long-term stability of the instrument and/or material.

TIME THEN RATE: Ends the test when the moisture evolved from the sample drops below the programmed microgram per second value, after the programmed time period has elapsed. This ending criterion is useful for samples that take a long time to heat up before evolving moisture, or, in other words, when the rate curve for a sample stays low for a period of time before rising significantly once the moisture starts evolving.

Selecting Sample Weight Entry Method

- Highlight **SAMPLE WEIGHT ENTRY**.
- Press [Selct].

MANUAL WEIGHT ENTRY: This method is used when a sample weight is measured with a precision balance. The program waits at the start of a test until the sample weight in grams is entered. Weights are accepted from 00.0000 to 99.9999 grams.

DIGITAL BALANCE: This method is used when a digital balance is connected to the instrument and the weight is communicated directly from the balance to the instrument.

FIXED SAMPLE WEIGHT: This method is used when all samples are of the exact same weight for accurate moisture analysis or close enough to an average value for approximate moisture analysis. The program will wait until a fixed weight value is entered.

Selecting Bottle Purge Control

- Highlight **BOTTLE PURGE CONTROL**.
- Press [**Selct**], then [**Edit**].

The bottle purge time is the time dry carrier gas flows through the sample bottle before a test begins. A value of 000 will disable the bottle purge. Any number other than 000 will adjust the purge time to that number of seconds. Average materials may use 30 to 45 seconds to purge the bottle. Samples that evolve moisture readily may need less than 30 seconds or no purge time at all. This parameter, along with temperature and ending criteria, may be adjusted to optimize results for any given material.

Note: There is also a Correlation Factor menu item in each memory start. This feature is not active at this time and this menu item cannot be selected.

12. DETERMINING OPTIMUM PARAMETERS

Correlation to Reference Method

For best accuracy and speed, the sample should evolve between 200 and 5,000 micrograms of water during the test. Larger amounts will not significantly improve accuracy and will only add to the test time. Smaller quantities will result in faster tests but may degrade accuracy, depending on the properties of the sample.

If you are attempting to match KF analysis results, find out what sample size and 'sensitivity' setting was used in the KF procedure. Use approximately 1.5 to 2 times as much sample in the Computrac® **VAPOR PRO® Rx**, and set the rate ending criteria value to the same 'sensitivity' value used in the KF equipment.

Example:	Karl Fisher	VAPOR PRO® Rx
Sensitivity setting	0.1 µg/sec	0.1 µg/sec
Sample Size	0.5 g	0.75 - 1 g

If you do not have the KF parameters available, perform the following experiment.

Use the following calculation to estimate the minimum sample size for 200 µg water.

$$\text{Minimum Sample Grams} = \frac{0.02}{\text{Expected Moisture}}$$

Example:

Expected Moisture is 0.05%

Minimum Sample = $0.02 / .05 = 0.4$ gram

The following table gives general guidance for the selection of sample size for various expected moisture levels. Note that the maximum sample size is also limited by the sample bottle. Do not fill the bottle over half full.

Table 1 - Sample Size

<u>Expected Moisture</u>	<u>Use</u>
.001 - .015% or 50-150 ppm	1.5 - 2 grams
.015 - .035% or 150-350 ppm	0.5 - 1.5 grams
.035 - .075% or 350-750 ppm	1 - 2 grams
.075 - .150%	0.5 - 1 gram
.150 - .350%	0.2 - 0.5 gram
.350 - .750%	0.1 - 0.2 gram
.750 - 1.5%	0.05 - 0.1 gram

These are only guidelines. Experiment with your sample to refine the size estimates to achieve your desired speed and accuracy. Note that if you are using a rate-ending criterion, and the peak moisture rate is less than five (5) times the rate threshold, the sample sizes should not be allowed to vary more than about 10%. Larger variation of sample size will lead to a larger variation of results. For your particular application, call AZI Customer Service at (800) 528-7411 or (602) 470-1414 for assistance in developing specific parameters.

After determining the optimum test parameters, repeat the test once to confirm the results.

For performance data, run 3 to 5 tests and use the following steps to determine the statistics.

- If this instrument is not 21 CFR, Part 11 compliant, select **STORED DATA** from the **MAIN MENU**,
- Select **ANALYZE STORED DATA**,
- Select the test results you want to analyze, and
- Press [**Calc**].

If this is a 21 CFR, Part 11 compliant instrument, all readings must be recorded by hand; AZI recommends using a printer to capture the values. The calculations must be performed on a calculator since the instrument's storage and analysis functions are disabled.

Mean, Standard Deviation, and Coefficient of Variation are calculated using the following formulas.

- Mean = total of results divided by number of results.
- Standard Deviation = $\sqrt{\frac{\sum(\bar{x} - x)^2}{n - 1}}$
- Coefficient of Variation = Standard Deviation divided by Mean times 100%

13. RUNNING MOISTURE TESTS USING UNSEALED BOTTLES

Tare a clean, empty sample bottle, including the septum and cap.

Based on the expected moisture content of the sample, determine optimum sample size using the chart on page 26. However, do not fill the bottle over ½ full so that sufficient carrier gas may flow and pick up evolved moisture.

ENSURE that the smooth, slick side of the septum is to the inside of the bottle.

Weigh the loaded bottle and record the weight of the sample.

TIP - The accessory balance, AZI P/N Y990-0082, eliminates possible transcription errors when entering the sample weight. It is also faster than manually taring and weighing the sample.

Press [START].

When prompted, enter the net sample weight and insert the bottle. The system will purge the bottle for a pre-determined amount of time. The sensor will again zero and the test will begin.

- For some applications, this bottle purge time may need to be reduced. If the expected results are not obtained after other parameters are adjusted, call AZI Customer Service at 800-528-7411 or 602-470-1414 for advice on how to reduce bottle purge time.
- An audible ‘beep’ will sound when the instrument has completed the test. Use the table on page 26 and the FINAL moisture reading on the display to adjust the sample size to optimize test time, repeatability, and accuracy.

RUNNING LYOPHILIZED MOISTURE TESTS

The Computrac[®] VAPOR PRO[®] Rx has 102 available positions to store test parameters for different materials. Storing the parameters ensures that each test of the same material will use the same parameters to assure accurate, reliable, and repeatable testing.

Weigh the sealed bottle and record the weight of the sample.

Press [START].

When prompted, enter the sealed bottle weight and insert the bottle. Hold lever down, position bottle between wires, release lever.

A beep will be heard when the test is complete.





CAUTION

The bottle transport, holder lever, and bottle are very hot when the test is finished and the transport extends. Do not touch the bottle with your bare hands until it has had time to cool. A glove may be needed to press the lever to open the bottle holder. Use the extractor tab at the bottom of the ramp to lift the bottle from the transport while opening the wire bottle holder with the lever.



Keep track of the bottles in the order of testing.

After all tests are complete, open and clean out the sample bottles.

Weigh the bottle, cap, and septa. (Weigh everything but the freeze-dried sample material). Record the weight by test number.

Go to the “STORED DATA MENU” and select “EMPTY BOTTLE WEIGHT.”

Enter the empty bottle weight for each test in the series.

This weight will be subtracted from the initial weight and the difference will be used as the sample weight in the analysis equations.

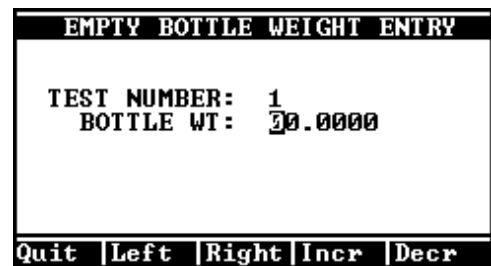

For questions or concerns, call AZI Customer Service at (800) 528-7411 or (602) 470-1414.

14. COMPUTRAC[®] VAPOR PRO[®] Rx MENU SYSTEM

In the idle state, the Main Test Screen displays menu access soft keys at the bottom. From left to right they are:

- **[Memry]** key - for accessing stored memory start selections,
- **[Menu]** key - for accessing the Main Menu, and
- **[Graph]** key - changes the display to a graph of the test's collected moisture and rate information.

Use the soft-key buttons below the display to make your selection.

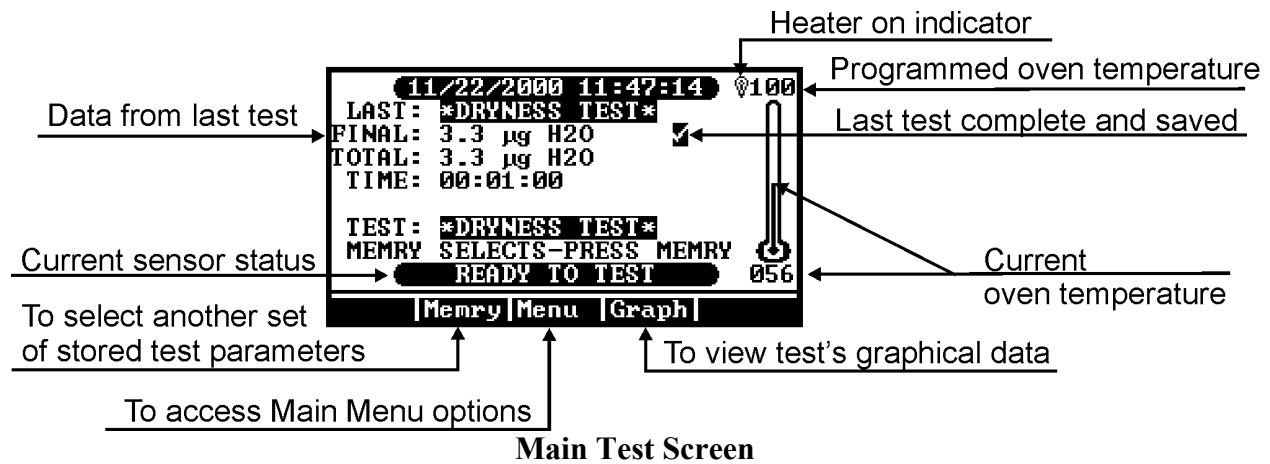

The **[Graph]** key will switch the display to the graphical displays.

- When you press **[Graph]**, the Total Moisture Graph appears and the name above the arrow button changes to **[Next]**.
- When you press **[Next]**, the graph changes to display the rate at which moisture is passing over the sensor.
- Further pressing **[Next]** will now toggle between the two graphs.
- To return to this Main Test Screen press **[Esc]**.

The [**Menu**] key brings up a screen showing the following options:

- MEMORY START MENU
- STORED DATA MENU
- CALIBRATION MENU
- SETUP MENU
- DIAGNOSTIC MENU

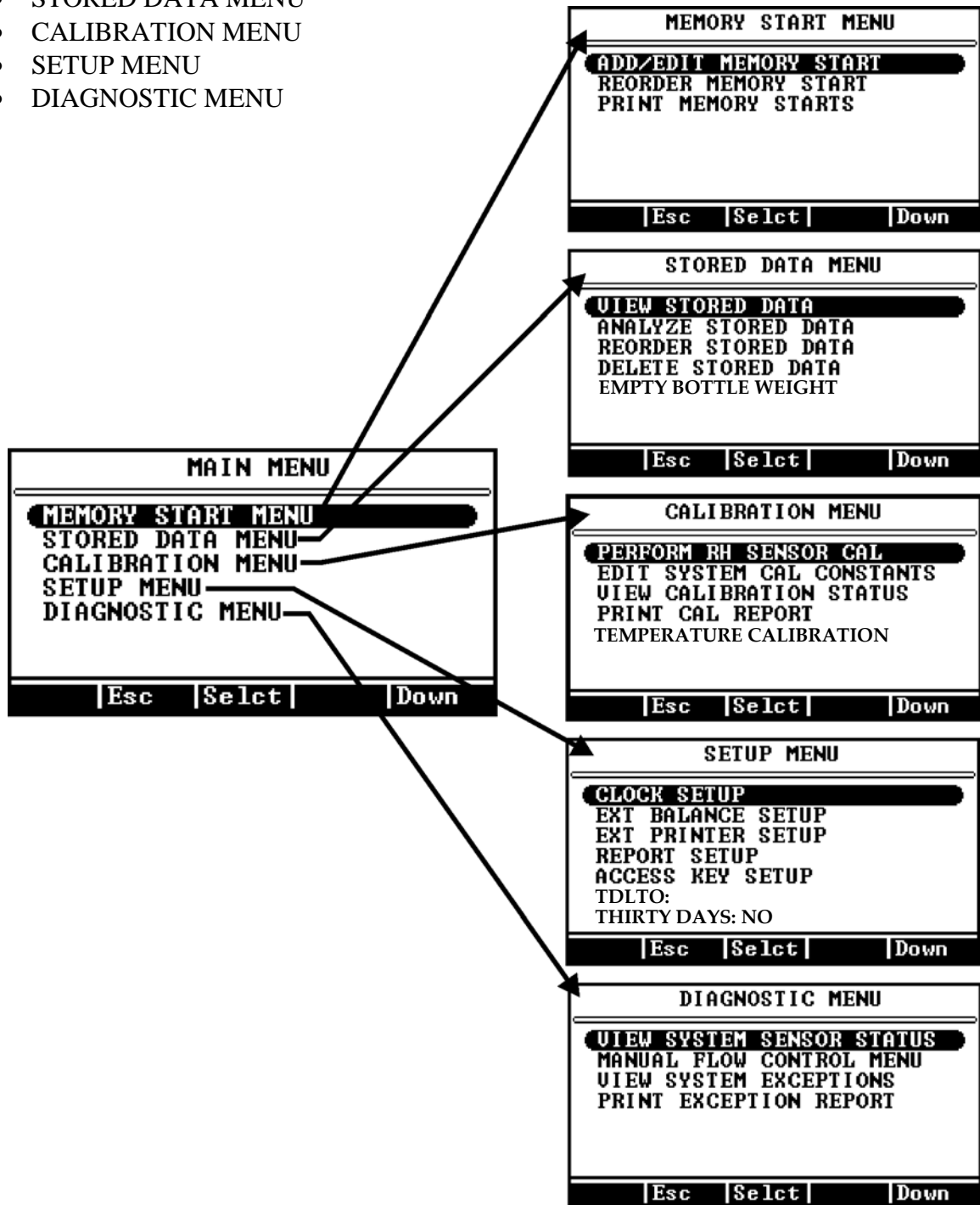

- Use the [**Up**] and [**Down**] keys to scroll through the selections.
- Use the [**Esc**] and [**Selct**] keys to “Escape” or “Select” your choice.

Memory Start Menu

- ADD/EDIT MEMORY START - lists of stored test parameter sets.
 - Sample ID: (Name)
 - Test Temperatures
 - Result Display Type
 - Ending Criteria
 - Method of Entering Sample Weight
 - Bottle Purge Control.
- REORDER MEMORY START - Allows the stored parameter sets to be rearranged, deleted, or copied.
 - Rearrangement is by “Cut-and-Paste” to an unused line or “Cut-and-Insert” between lines.
 - Deletion is by cutting without pasting to a location.
 - Entry of a new parameter set that is close to an existing one is done by the “Copy-and-Paste” or “Copy-and-Insert” method. Only the different parameters need to be edited to the new values.
- PRINT MEMORY STARTS
 - Prints a list of the stored parameter sets on the attached printer, or computer.
 - Printing must be enabled and programmed. Go to the **SETUP MENU**, **EXT PRINTER SETUP** and **REPORT SETUP MENUS**, to select the port and report content.

```
EDIT MEMORY START #02
-----
EDIT SAMPLE ID
TEMPERATURES
RESULT DISPLAY OPTION
ENDING CRITERIA
SAMPLE WEIGHT ENTRY MODE
BOTTLE PURGE CONTROL
-----
|Esc| |Selct| |Down|
```

Stored Data Menu (Not available on 21 CFR, Part 11 compliant instruments)

- VIEW STORED DATA - Allows viewing and printing of all data stored for a given test.
- ANALYZE STORED DATA - Permits selection of stored data sets for statistical analysis. Statistical analysis includes mean, standard deviation (S.D.) and coefficient of variation (C.V.).
- REORDER STORED DATA - Rearranges the order of the list of stored data sets. It also deletes sets no longer needed, or copies existing sets to another location using the “cut-and-paste” method.
- DELETE STORED DATA - Facilitates deletion of selected data sets. Selection may be made by line, date or all items.
- EMPTY BOTTLE WEIGHT – Lyophilized sample bottles can be weighed after testing and the sample has been removed. (See page 25).

Calibration Menu

- **PERFORM RH SENSOR CAL** - A program to be used carefully and only when required to calibrate the moisture sensor. This selection uses stored data sets and calibrated microcapillary tubes to calculate and execute the automatic adjustment of the instrument. The result is a stored parameter, Cal Constant, and may be viewed in the Edit System Cal Constants menu.
- **EDIT SYSTEM CAL CONSTANTS** - This selection allows the entry of:
 - The two sensor constants RH Sensor V0 and V75 found on the sensor PCB and entered when a sensor is replaced.
 - The calculated offset value entered by the instrument during a RH Sensor Calibration. This value should only be changed by the instrument because of a sensor calibration.
- **VIEW CALIBRATION STATUS** - This selection allows review of:
 - The criteria used for RH Sensor calibration,
 - RH Sensor adjustment status, and
 - Flow Rate Sensor calibration.
- **PRINT CAL REPORT** - Prints all available calibration status reports.
- **TEMPERATURE CALIBRATION** - This selection initiates the menu that allows calibration of the internal oven. Section 10 of this manual explains the temperature calibration and verification procedure.

```
EDIT SYSTEM CAL CONSTANTS
-----
RH SENSOR V0: 0.837 U
RH SENSOR V75: 3.100 U
SYSTEM CAL: 100%
-----
Print|Esc |Edit | |Down
```

Setup Menu

- CLOCK SETUP - Set the internal clock for the correct time and date.
- EXT BALANCE SETUP - Select the type of external balance: AZI ZSP150/SP150 or SCI SA80. For more information, see **COMMONLY ASKED QUESTIONS**.
 - Select the tare mode. (Fixed weight, manual bottle weight entry, or balance entry)
 - Test the communication link between the instrument and balance.
- EXT PRINTER SETUP - Selects the type of printer used and the data output port (RS-232, LPT, or both).
 - Select EPSON RASTER for the Epson[®] C88+ printer (Y990-0098).
 - Select SEIKO DPU for the Seiko[®] DPU-414 Mini printer (Y990-0120).
- REPORT SETUP
 - **Report Control** specifies:
 - ◆ Report Start (off, start of a test, end of a test),
 - ◆ Report Format (text or spreadsheet),
 - ◆ Report Interval (00 to 99 seconds),
 - ◆ Automatic Form Feed (End of line form feed ON or OFF)
 - ◆ Include Graph (none, result, rate, both), and
 - ◆ Lot Number (recording ON or OFF).
 - **Report Content** includes or excludes particular items of information in the report. These items are:
 - ◆ Memory Start Number
 - ◆ Memory Start ID
 - ◆ Lot Number
 - ◆ Product ID
 - ◆ Test Date
 - ◆ Time of Day
 - ◆ Final Result (ppm or %)
 - ◆ Final Mass (micrograms H₂O)
 - ◆ Ending Criterion
 - ◆ Sample Weight
 - ◆ Test Time
 - ◆ Test Temperature
 - ◆ Ending Rate (micrograms/sec at end of test)
 - ◆ Peak Rate
 - ◆ Peak Time
 - ◆ Flow In
 - ◆ Purge Time
 - ◆ Sensor Block Background
 - ◆ Bottle Weight
 - **Edit Company Name** is the company name that prints on the header line of the report. This 22-character entry may be changed to reflect the customer's company or department.

- ACCESS KEY SETUP - Allows entry of the passwords used to prevent unauthorized alteration of stored parameter sets, or stored data sets.
 - KEY ENABLE - OFF to disable access protection and ON to enable access protection
 - MASTER KEY - controls all functions.
 - CALIBR KEY - controls calibration access.

- TDLTO: - Allows entry of an AZI-supplied password that will override a factory lockout feature. This lockout feature is used on AZI-owned analyzers that are loaned to customers for a short period, so it is not used on customers' equipment.

- THIRTY DAYS - Displays the status of the factory lockout feature.

Diagnostic Menu

- VIEW SYSTEM SENSOR STATUS - Displays the current value of:
 - RH measured by the RH sensor (RH SENSOR),
 - Flow in rate in milliliters per minute (FLOW IN),
 - Sensor block temperature (BLOCK RTD), RTD stands for Resistive Temperature Detector and describes the solid-state devices used throughout the instrument to measure temperatures.
 - Bottle heater temperature (BOTTLE RTD),
 - RH sensor temperature (RH RTD),
 - H₂O flow rate, in micrograms per second, and
 - Instrument flow mode, usually standby when not performing a test and not in manual flow control.

SENSOR STATUS	
RH SENSOR:	00.300 % RH
FLOW IN:	075 mL/Min
BLOCK RTD:	068 °C
BOTTLE RTD:	051 °C
RH RTD:	072 °C
H2O FLOW:	0001.1 ug/Sec
FLOW MODE:	LOW

Esc

CT-3500-L

SENSOR STATUS	
RH SENSOR:	00.300 % RH
FLOW IN:	100 mL/Min
BLOCK RTD:	068 °C
BOTTLE RTD:	119 °C
RH RTD:	072 °C
H2O FLOW:	0001.1 ug/Sec
FLOW MODE:	LOW

Esc Units

CT-3500

- MANUAL FLOW CONTROL MENU - This menu allows manual control of the carrier gas flow mode for test and analysis of possible system faults. There are three selections.
 - **Manual Off** - returns the system to automatic control of the flow state.
 - **High Flow** - high flow through the needle and RH sensor for system drydown.
 - **Low Flow** - normal flow through the needle and RH sensor
 - **Bottle Purge** – high flow to assist in drying bottles
 - **Transport In** – moves the bottle transport into the unit for factory service and troubleshooting.
 - **Transport Out** – moves the bottle transport out of the unit for factory service and troubleshooting.



If any manually controlled flow state is used, ensure the manual flow control is set to **OFF before attempting normal operation. If this is overlooked, an error message will appear on the screen.**

- VIEW SYSTEM EXCEPTIONS - A list of up to 20 faults detected by the instrument diagnostic system. Print the list and fax it to AZI Customer Service at (480) 804-0656 to assist in diagnosis of possible system failure.
- PRINT EXCEPTION REPORT - Prints the stored list of instrument diagnostic exceptions.

15. CONDITION PROMPTS and SYSTEM FAILURE CODES

To assure proper performance, your Computrac[®] VAPOR PRO[®] Rx uses an intelligent self-diagnostic system to detect any problems in the hardware, software, sensors or flow system. Operating abnormalities and fault conditions will result in **condition prompts** or **system failure codes**. They will be recorded in the Exception Reports table.

Condition Prompts

Condition prompts indicate operating conditions that prevent starting or completing a moisture test. Following each condition prompt are possible causes and recommended solutions.

- **“INPUT CARRIER GAS FLOW LESS THAN 40 mL/min”**

This prompt appears when the carrier gas flow into the instrument falls below the specified rate.

Possible Cause	Recommended Solution
Source of carrier gas not connected	Connect source
Source pressure too low	Increase source pressure to 20 psi
Flow system filter plugged	Remove and replace filter
Source connected to ‘flow out’ barb	Connect to ‘flow in’ barb
Flow sensor failure	Call Arizona Instrument
Blocked needle	Check that bottle septum is not blocking needle port

- **“THE RH SENSOR WAS NOT READY”**

This is a normal condition between tests, indicating the drying or ‘zeroing’ of the sensor. If the condition persists for more than a few minutes then:

Possible Cause	Recommended Solution
Flow system contaminated	Locate and eliminate contamination
System unusually wet	Wait for system to dry
Wet source gas	Install/change external desiccant chamber

- **“BALANCE COMM FAILURE”**

This prompt indicates that the selected memory start specifies the weight input from a digital balance but the instrument is not communicating with a balance. Check the cable, and assure that the balance is powered on, is on line, and stable.

System Failure Codes

Occurring less frequently than condition prompts, system failure codes require the instrument to be switched off and then powered back up. It is possible for a failure to occur due to a transient condition. However, if the failure persists or occurs frequently, call Arizona Instrument Customer Service at (800) 528-7411 or (602) 470-1414.

ERROR	ERROR MESSAGE TEXT	MOST LIKELY CAUSE
2	PC KEYBOARD COM FAIL	BAD CABLE OR CONFIG
3	PC KEY CONTROLLER TIMEOUT	DEAD KEYBOARD
5	RH SENSOR RANGE ERROR	FAILED RH SENSOR
6,7	FLOW SYSTEM ERROR	CABLE OR SENSOR FAIL
8	RH RTD RANGE ERROR	CABLE OR RTD FAIL
9	RH RTD RATE ERROR	Sensor Block HEATER
10	RH RTD TRACK ERROR	Sensor Block RTD OUT OF POSITION
11	BOTTLE RTD RANGE ERROR	CABLE OR RTD FAIL
12	BOTTLE RTD RATE ERROR	BOTTLE HEATER FAILURE
13	BOTTLE HEATER OVERTEMP	BOTTLE HTR RTD OUT OF POSITION
14	BOTTLE HTR CONTROL ERR	ROOM TOO COLD
15	Sensor Block RTD RANGE ERROR	CABLE OR RTD FAILURE
16	Sensor Block RTD RATE ERROR	Sensor Block HEATER FAILURE
17	Sensor Block HEATER OVERTEMP	Sensor Block RTD OUT OF POSITION
18	Sensor Block HTR CONTROL ERR	Sensor Block HTR OUT OF POSITION
19	A2D INIT FAILED	COMPONENT FAILURE, MAIN BOARD
20	A2D TIMEOUT ERROR	COMPONENT FAILURE, MAIN BOARD
21	MCU CLOCK FAIL ERROR	COMPONENT FAILURE, MAIN BOARD
22	COP TIMEOUT ERROR	COMPONENT FAILURE, MAIN BOARD
23	ILLEGAL OP CODE TRAP	COMPONENT FAILURE, MAIN BOARD
24	EPROM CHECK SUM FAIL	COMPONENT FAILURE, MAIN BOARD
25	SRAM CHECK FAIL	COMPONENT FAILURE, MAIN BOARD

16. COMMONLY ASKED QUESTIONS

Below are some commonly asked questions with answers and possible solutions.

Q: “What if my calibration check results are out of range?”

A: **Perform a sensor calibration.** The Computrac® **VAPOR PRO® Rx** self-adjusts the internal calibration factors to the high precision moisture sensor, due to varying conditions (temperature, product accumulation in the flow system, component wear, etc.). Over time, this may cause the overall calibration to drift slightly. Since sensor calibration is easily performed, daily verification is recommended.

Q: “How do I dry the instrument after an upset?”

A: In case the instrument has been flooded with moisture, either by running a very wet sample, or by exposure to a wet atmosphere, it will be necessary to dry the entire flow system before normal operation can be resumed.

- Inspect the tubing, the needle, the sensor block, and if a filter is used on the instrument, inspect the filter also to be sure that no contaminants are present that might absorb and release large quantities of water. If contamination is present, replace the contaminated parts with new parts.
- Confirm that the carrier gas supply is dry. If there is any doubt about this, employ a drying cylinder in line with the gas supply before connecting it to the instrument gas input fitting. We highly recommend using an in-line desiccant to prevent unexpected contamination or to minimize any variation in carrier gas moisture levels.
- Go to the memory start list and select ***DRYNESS TEST*** Press **[Start]**.
- Periodically examine the rate graph display to see if the moisture rate is falling.
 - Normally, the rate will begin to decline after 30 seconds, and eventually will fall to less than 1 µg/sec at which point, testing can resume.
 - If the moisture rate remains at a very high level until the end of the test, a source of water is present in the system and must be removed before the system will dry out.

Q: “What if the instrument indicates low flow when the input pressure is adequate?”

A: #1 The needle may be clogged. Use the following procedure to clean the needle assembly and sensor chamber. For assistance, call AZI Customer Service at 800-528-7411 or 602-470-1414.

- Set instrument oven temperature to 80 °C or below.
- Obtain several ounces of isopropyl alcohol (IPA).
- Fill a sample bottle ½ to ¾ full with IPA; fit with a cap and septum.
- Place an empty sample bottle at the outlet port at the back of the instrument to catch expelled solvent.
- From the MAIN TEST SCREEN, navigate MENU→DIAGNOSTIC MENU→MANUAL FLOW CONTROL MENU, and switch the MANUAL FLOW CONTROL to BOTTLE PURGE.
- After 5-10 seconds, solvent should begin to be expelled from the outlet port at the back of the instrument.
- When solvent expulsion slows or stops, switch MANUAL FLOW CONTROL to TRANSPORT OUT.
- Remove the sample bottle with the remaining solvent from the sample transport.
- Switch MANUAL FLOW CONTROL to MANUAL OFF.
- Escape to the MAIN TEST SCREEN by press ESC three times.
- Wait for the Status Bar to read “READY TO TEST” before resuming normal operation. This typically takes 15 to 30 minutes.

A: #2 There may be a leak in the flow system. If cleaning the needle according to the above procedure did not resolve the issue, there may be a leak in the flow system. Call AZI Customer Service at 800-528-7411 or 602-470-1414 for assistance.

Q: “What about interferences?”



A: The only known interferences are from ammonium hydroxide, ethanol, methanol and acetone. Samples containing these and similar chemicals should never be used. Additionally, never use these substances as cleaning agents in or on the Computrac[®] VAPOR PRO[®] Rx. Use isopropyl alcohol for cleaning instead.

Q: “Why do my tests sometimes end in less than 2 minutes?”

A: This is usually caused by an inappropriately large rate ending criterion value or small sample size. When using the rate-ending criterion, you entered a rate value to end the test. If the sample moisture is very low, or the sample is too small, the peak rate may never exceed the ending rate and the instrument concludes that the test is over. To rectify this, use a larger sample, or a lower ending rate value. See “*Selecting How to End the Test*” beginning on page 22.

Q: “How do I transfer stored data to a computer file?”

A: This is not available in 21 CFR, Part 11 compliant instruments. To store archival information from non-compliant instruments to a computer text file:

- Set up the instrument to print to the RS-232 port. (Setup Menu, External Printer Setup).
- Go to Setup Menu, Report Setup, Report Control and select text output.
- Set up the computer to receive text information into its serial port at 9600 baud, no parity, 8 data bits and 1 stop bit (9600,N,8,1). Windows[®] Terminal or Windows[®] HyperTerminal are good choices for this purpose. Consult the documentation for your communications program for details on how to save input data to a file.
- Go to the menu showing the print features and select print.
 - Memory Start Menu - Print Memory Starts
 - Calibration Menu - Print Cal Reports
 - Diagnostic Menu - Print Exception Report

Q: “How do I print to a printer?”

A: To print test results or stored data:

- Connect the printer to the parallel port on the back of the instrument. Use the accessory printer from AZI, or a standard PC graphics printer and cable.
- Make sure the printer is supplied with paper, the printer power is on, and the printer is on-line.
- Go to Setup Menu, and External Printer Setup. Select the Printer Type and LPT port.
 - NOTE: Use EPSON RASTER for the Epson[®] C88+ printer.
 - NOTE: Use SEIKO DPU for the Seiko[®] DPU-414 Mini printer (Y990-0120).
- Go to Setup Menu, Report Setup, and Report Control. Select text output.
- Go to the screen showing Print and select the report to be printed.

Q: “How do I set up the Computrac® VAPOR PRO® Rx to use the AZI ZSP150/SP150 or SCI SA800 digital balance?”

A: Follow the steps below.

- Beginning at the Starting Screen, select the prompts in order:
 - Main
 - Setup
 - Ext Balance setup
 - Select Balance Driver

- Select the AZI SP150 or SCI SA800 according to the balance you have. (Use AZI SP150 as the selection for both the ZSP150 and the SP150).
 - Select Quit
 - Select Accept

- Select Tare Mode.
 - Fixed Bottle Weight if all sample bottles weigh the same or the same bottle is used again.
 - Manual Bottle Weight if all bottles are pre-weighed by hand.
 - Weigh Empty Bottle if the balance is to tare weigh each bottle before it is filled with sample.

- Escape [Esc] to the Ext Balance Setup Menu.
- Connect the cable between the Computrac® VAPOR PRO® Rx Balance Input and the balance RS-232 Connector.
- Turn the balance power on and wait for the ready indication.
- Select Check Balance Comm on the Ext Balance Setup Menu.
 - Select Go and wait for communication to be established.
 - If the check is bad, verify each step above.
- If the check indicates good communication, a weight will be shown on the Computrac® VAPOR PRO® Rx display.
- If the check is good, press [Esc] until the Main Test Screen is displayed. If not, recheck the cables and setup conditions.

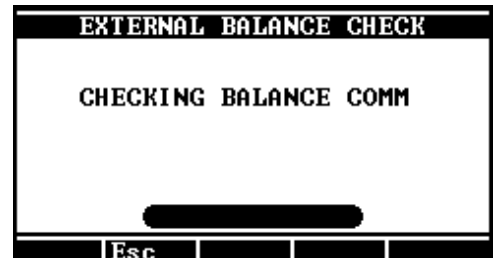
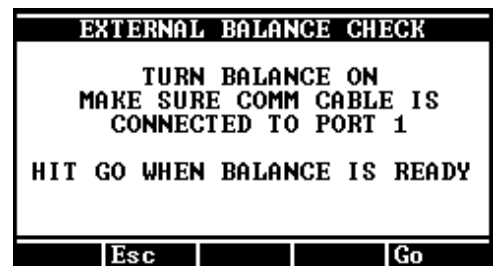
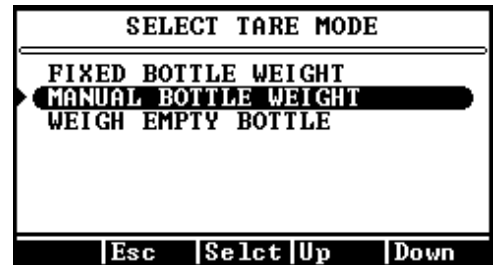
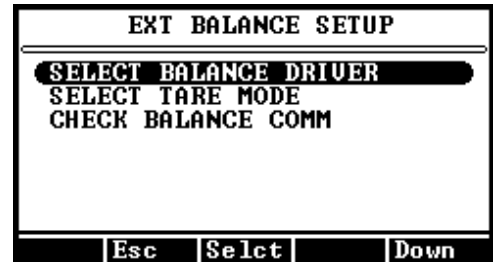
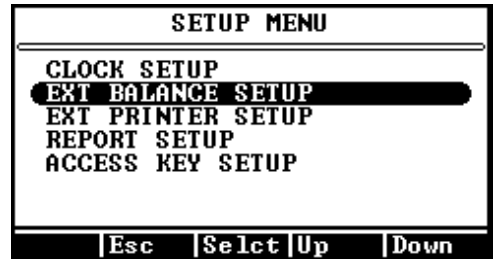

17. REPAIR AND MAINTENANCE

Routine maintenance consists of checking the Hydrophobic Filter for clogging or contamination, checking the needles for clogs, and cleaning the flow path between the needle and the filter. For clean samples, such as most plastic resin pellets, this is seldom necessary. For very dusty, high moisture or high volatile content samples, it may be necessary more often.

⚠ CAUTION: ⚠

Line voltage is present under the instrument's cover. To prevent electrical shock, turn off power, and remove the power cord. Do not re-connect the power cord and turn power on until after the cover is secured in place.

ACCESS COVER REMOVAL

- Refer to this procedure to gain access to the internal parts as directed in other sections of this manual.
- Turn the instrument off and remove the power cord from its socket.
- Insert a small probe into the hole at the back of the instrument marked by a graphic symbol indicating the method of opening the access cover.
- Push inward to release the safety catch, and lift the cover up with your free hand.
- Remove it and put it in a safe place.



INSTRUMENT COVER REMOVAL

- Remove the access cover. See **ACCESS COVER REMOVAL** on page 42.
- **The sensor block is hot (68 °C); do not touch it with bare hands until it has been allowed to cool down.**
- Remove the instrument cover by unlatching the two latches on the back chassis wall. A long screwdriver is helpful.



TO INSPECT THE FILTER AND TUBING:

- Unplug the power cable.
- Remove the cover See **ACCESS COVER REMOVAL** on page 42.
NOTE: Not all instruments use a Hydrophobic Filter but if it is used, it is visible at right center, above the Sensor Block.
- Examine the filter and tubing. If a deposit or discoloration is observed in the clear tubing between the filter and the Sensor Block, the filter and tubing should be replaced, and the entire sample flow path cleaned with isopropyl alcohol.

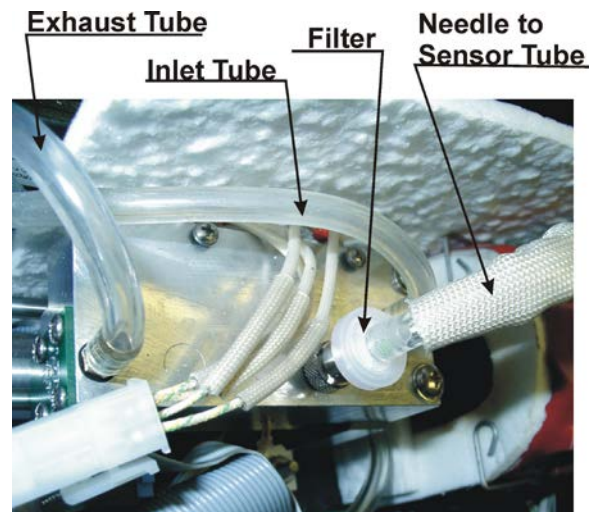

*****IMPORTANT*****



Never use methanol for cleaning any part of the instrument. Methanol interferes with calibration of the RH sensor, and is very difficult to remove from the flow system.

When used, the Hydrophobic Filter on top of the Sensor Block must be replaced if it becomes contaminated. Replace it only with the Hydrophobic Filter available from Arizona Instrument (AZI Part No. 990-0059). Before replacing a filter, it is good practice to flush the new filter with dry carrier gas to remove moisture adsorbed to the interior of the filter. After replacing the filter on its holder, replace the top cover before connecting the instrument to its power source. Turn the instrument on and when READY TO TEST appears, run the dryness test procedure outlined on page 14 using a clean dry empty sample bottle. When this procedure ends, the system is ready for use. Factory replacement of the Hydrophobic Filter is available and recommended.

Q: “How do I change the filter?” Not on all instruments.

A: First, obtain a replacement Hydrophobic Filter, AZI Part Number 990-0059. One filter was contained in the accessory kit. If it has been used, call AZI Customer Service at (800) 528-7411 or (602) 470-1414 for a replacement.

- Remove the power cord from its socket.



Line voltage is present under the instrument’s cover. To prevent electrical shock, turn off power and remove the power cord when instructed to do so. Do not re-connect the power cord and turn power on until after the cover is secured in place.

- Remove the cover See **ACCESS COVER REMOVAL** on page 42.
NOTE: Not all instruments use a filter but if it is used, it is visible at right center, above the Sensor Block.
- The filter, or the Luer adaptor for mounting the filter, will be found near the center on top of the Sensor Block. Pull the tubing from the adaptor or filter disk. If replacing an old filter, rotate it counterclockwise and lift it off. Discard the old filter.



- Install a new filter by rotating it clockwise until finger tight. Reattach the clear tubing. If condensed material is visible in the tubing, replace the tubing. Note that this is a special type of hydrophobic tubing. The proper tubing is available from AZI as AZI Part Number 345-0050.
- Replace the top cover and power cord.
- Turn the instrument on and perform a ***Dryness Test***. (See page 14.)
- When the purge process concludes, the instrument is ready for normal use.



Q: “How do I Adjust the Dry Air Flow?”

⚡ CAUTION: ⚡

Line voltage is present under the instrument’s cover. Use care not to touch any components except those listed in the following procedure to prevent electrical shock.

A: Follow the steps listed below.

- Verify the pressure of the carrier-gas supplied to the instrument is between 17 and 22 psi.
- Unplug the power cable.
- Remove the cover. See **ACCESS COVER REMOVAL** on page 42.
- Remove the instrument cover. See **INSTRUMENT COVER REMOVAL** on page 43.
- Plug the power cord back in and turn the instrument ON.
- From the MAIN TEST SCREEN, select the following menus:
 - MENU,
 - DIAGNOSTIC MENU, and
 - VIEW SYSTEM SENSOR STATUS

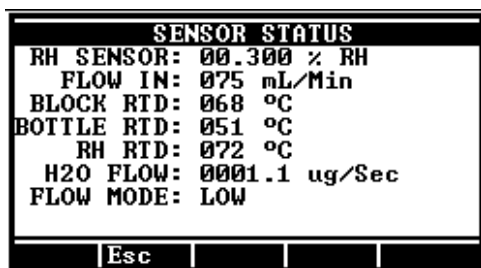

CT-3500-L

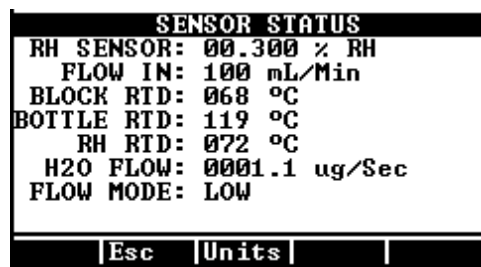

CT-3500

- If FLOW IN is not 75 ± 2 mL/min (CT-3500-L) or 100 ± 10 mL/min (CT-3500), adjust the pressure regulator. There are two configurations of the flow regulator.

- On older instruments:

- Locate the flow regulator that is mounted to the right of the display.
- Loosen the lock nut on the adjustment screw and slowly adjust the hex-head screw on top of the inlet flow regulator CLOCKWISE or COUNTER-CLOCKWISE until the FLOW IN indicates 75 mL/min (CT-3500-L) or 100 mL/min (CT-3500).
- Tighten the lock nut.

- [Esc] to the MAIN TEST SCREEN.
- Turn the instrument off
- Remove the power cord from its socket.
- Replace the Instrument cover, access cover, and power cord.
- Turn the instrument on.
- The instrument is ready for normal use.

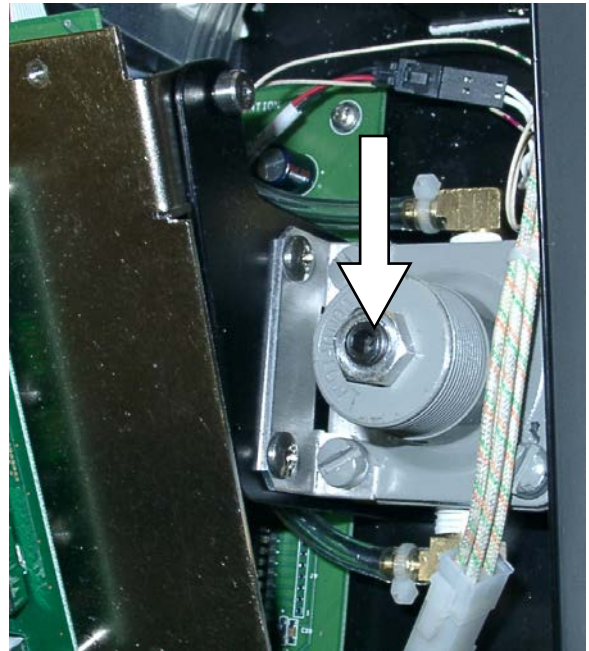

- On newer instruments:

- Locate the flow regulator that is mounted to the right of the display.
- Loosen the knurled lock ring on the regulator, then insert a regular screwdriver in the slot on the top of the regulator.
- Turn the screwdriver slowly CLOCKWISE or COUNTER-CLOCKWISE to adjust the inlet flow regulator until the FLOW IN indicates 75 mL/min (CT-3500-L) or 100 mL/min (CT-3500).
- Re-tighten the knurled lock ring.

- [Esc] to the MAIN TEST SCREEN.
- Turn the instrument off.
- Remove the power cord from its socket.
- Replace the instrument cover, access cover, and power cord.
- Turn the instrument on.
- The instrument is ready for normal use.

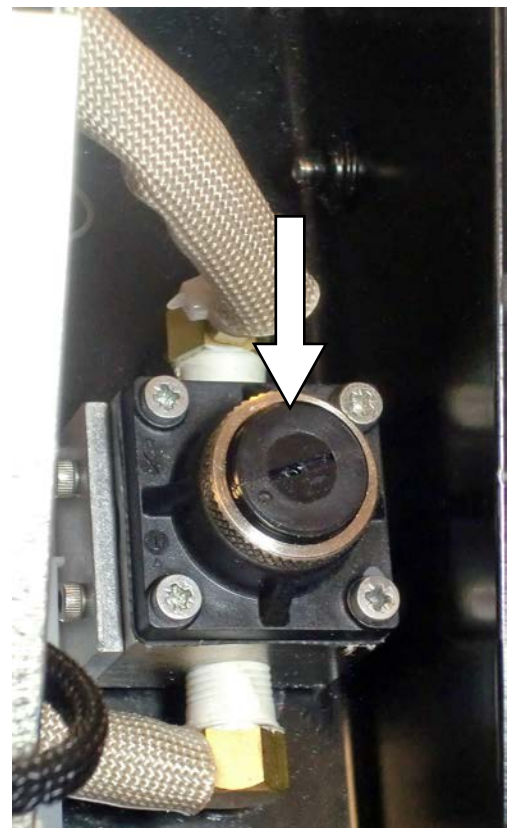

18. SPECIFICATIONS AND RATINGS

These specifications are intended as a guide to proper use of the instrument. Specifications and features will vary with application. AZI product specifications are controlled by ISO-9001 procedures and are established and verified during design. They are not to be construed as test criteria for every application. Refer to AZI document Number 720-0036 for current specifications controlling this instrument. All specifications and features are subject to change without notice. Periodically contact Customer Service to see if any upgrades are available for your instrument. Customer Service may be reached by phone at (800) 528-7411 or (602) 470-1414. If you prefer the Internet, contact Customer Service at the Arizona Instrument web site, <http://www.azic.com> or e-mail direct at support@azic.com.

Dimensions:	Approximately 150 mm (5.75") H x 370 mm (14.5") W x 360mm (14") D (not including the bottle loader/ramp). Standard bottle loader/ramp adds about 90 mm (3.5") to the width.
Weight:	Approximately 8.6 kg (19 lbs.)
Sample Bottle Size Range	Outside Diameter from 13 mm to 37 mm (approximately 0.5" to 1.5") Overall Length from 29.5 mm to 65 mm (approximately 1.16" to 2.5")
Power Ratings:	100-120 V~, 50/60 Hz, 8 amps maximum, or 220-240 V~, 50/60 Hz, 4 amps maximum
Environmental Requirements:	5 to 40 °C, 0 to 80% RH, non-condensing, indoor use. Optimum results are obtained from 20 to 40 °C.
Heating Range:	25 °C to 275 °C, electronically controlled
Heater Control:	Temperature controlled to $\pm 1^{\circ}\text{C}$ of set point
Lower Detection Limit:	0.1 micrograms
Special Service Carrier Gas:	Dry nitrogen or dry air (-40 °C dew point, or lower is suggested) at 17 to 22 psi. (User supplied)
Rear Panel Connections:	Parallel printer port (PC standard) 9 pin RS-232 (9600,N,8,1) 9 pin Balance Comm. (proprietary protocol and cable) Power cable receptacle with RFI filter Carrier gas input barb fitting Carrier gas outlet port - used for test only
Side Panel Connections:	PC keyboard DIN socket
Resolution:	0.1 micrograms, 1 ppm, 0.0001%
Repeatability:	Depends on sample properties and capillary tube technique, typically CV is less than 10% for moisture levels above .1% and 15% for moisture levels below .1%
Automatic Test Ending Method:	Rate Threshold, user adjustable Time, user adjustable Prediction Time then Rate, user adjustable
Certifications	US and Canadian Underwriters Laboratory / European Communities CE Arizona Instrument LLC is an ISO9001 Registered Company

19. WARRANTY

Arizona Instrument LLC warrants the Computrac® **VAPOR PRO® Rx** to be free from defects in materials or workmanship for two (2) years from the date of purchase for those instruments sold in the USA. All international sales normally carry a one (1) year warranty. AZI will repair or replace, at its option, products that AZI determines to be defective during the warranty period. All defective parts replaced by AZI become the property of AZI. Replacement parts are warranted for the remaining portion of the effective warranty period. This warranty does not apply to expendable or consumable items or routine maintenance.

The above warranty does not extend to any product which has been subjected to misuse, abuse, neglect, accident, improper application, modifications or service performed by persons other than AZI's own service representatives; power surges or spikes; negligence in use, maintenance, storage, transportation or handling; or acts of God.

If a **VAPOR PRO®** product is defective in workmanship or materials, the owner's sole remedy shall be repair or replacement of the defective part, or parts, as provided above. Under no circumstances shall AZI be liable in any way to the owner or any user for any damage including, but not limited to, any loss of business or profits or any other direct, indirect, special incidental, or consequential damages, whether or not foreseeable, and whether or not based on breach of warranty, contract, or negligence in connection with the sale of such products. (Some states do not allow the exclusion or limitation of incidental or consequential damages, so the above limitations or exclusions may not apply to you.)

No other warranty is expressed or implied including the warranties of merchantability or fitness for a particular purpose. In no event shall AZI be liable for consequential and/or incidental damages.

The effective warranty begins on the date of purchase by, or lease to, the first end-user (owner). Keep the dated bill of sale, or invoice, for evidence of the effective warranty date when warranty service is requested.

In the event that any questions or problems should arise in the use or application of your Computrac® **VAPOR PRO® Rx** instrument, call AZI Customer Service or your technical sales representative.

Contact Customer Service for extended warranty information.

TRADEMARK AND COPYRIGHT PROTECTION

Computrac[®], **VAPOR PRO[®]**, Arizona Instrument[®], AZI[®] and the stylized AZI are all registered trademarks of Arizona Instrument LLC. Instrument firmware is copyright protected.

All specifications subject to change without notice.

US Patents Nos. 5,712,421; 6,561,012
Other US and Foreign Patents Pending

© Copyright 2002-2013 Arizona Instrument LLC. All Rights Reserved.

Drierite[®] is a registered trademark of W.A. Hammond Drierite Company, Ltd.
Epson[®] and Seiko[®] are registered trademarks of Seiko Epson Corporation.
Teflon[®] is a registered trademark of E.I DuPont de Nemours Company.
Windows[®] is a registered trademark of Microsoft Corporation in the United States and other countries.

Arizona Instrument LLC
Computrac[®] VAPOR PRO[®] Rx Moisture Analyzer User Manual
Part Number: 700-0050
Revision G
August 2013

If you have any questions regarding the operation of this instrument, contact Arizona Instrument Customer Service. You may call our toll free number from the US and Canada, (800) 528-7411. Our fax is (480) 804-0656. Internationally, or in the Phoenix area, call (602) 470-1414.

If you prefer the Internet, contact Customer Service at the Arizona Instrument web site, <http://www.azic.com> or e-mail direct at support@azic.com.

Arizona Instrument LLC
3375 N Delaware Street
Chandler, AZ 85225 USA

<http://www.azic.com>

email:

azi@azic.com - General
intl@azic.com - International
support@azic.com - Customer Support