

Installation & Maintenance Instructions

Verabar V250

Hand Insert



VERIS

1.0 SCOPE

These instructions provide procedures for installing the V250 Verabar flow sensor. Procedures are given for all industrial flow measurement applications including liquid, steam and gas service for both horizontal and vertical piping configurations.

2.0 RECEIVING INSPECTION

The following tasks should be performed as part of the receiving inspection procedure:

- Check items received against the packing list.
- Check sensor nameplate for proper model number, serial number and customer number.
- Verify that the actual pipe diameter matches the ID stated on the sensor nameplate.
- Check the bullet shaped sensor tube for any signs of damage. Damage to the sensor tube may result in erroneous flow readings.
- Check the round cover tube for any damage, especially axial gouges or scratches. Damage to the cover tube may prevent the packing from sealing properly.

3.0 SAFETY PRECAUTIONS

Prior to installing the Verabar flow sensor, check maximum operating conditions on the sensor nameplate and verify that they exceed the maximum conditions of the installation. If any pressure, temperature or flow limits will be exceeded, consult the factory before proceeding.

Warning: The V250-10 can withstand a maximum pressure of 30 psig (2 Bars) and the V250-15 can withstand a maximum pressure of 10 psig (.7 Bar). Do not insert the V250 in pipes with pressures greater than 30 psig (2 Bars).

4.0 INSTALLATION PREPARATION

4.1 Location

For the most accurate flow measurement, a minimum straight run of pipe is required. Table 1 shows the minimum straight run requirements. If longer straight runs are available, position the Verabar such that the ratio of upstream straight run to downstream straight run is approximately 4 to 1. If straight run lengths are less than the values stated in Table 1, consult the factory for additional accuracy and location information. For additional piping configurations, see Drawing SUB-4521.

Position straightening vanes such that the end closest to the Verabar is half way between the Verabar and the closest upstream configuration. For elbow installations, mount the Verabar in the same plane as the closest upstream elbow.

4.2 Orientation

Verify the proper sensor orientation by checking for an “H” (horizontal piping) or a “V” (vertical piping) in the model number on the Verabar name plate. Verify that the flow arrow stamped on the instrument head is pointing downstream in the direction of flow.

4.2.1 Horizontal Piping

For air or gas installations, mount the Verabar in the upper 160° of the pipe to allow any condensate to drain into the pipe (Figure 1). For liquid or steam installations, mount the Verabar in the lower 160° of the pipe. This allows any entrained air to bleed back into the pipe for liquid applications and allows condensate to collect in the instrument piping for steam applications.

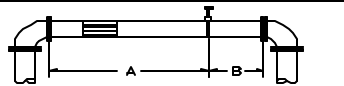
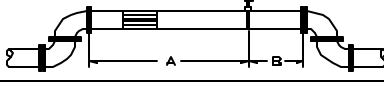

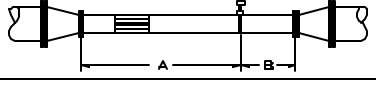
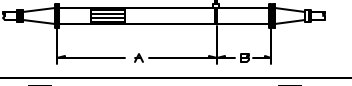
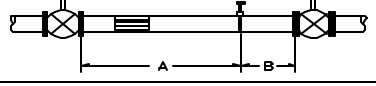
Piping Configuration		Dimension —A—		Dimension —B—
		Without Straightening Vanes	With Straightening Vanes	
Elbow		7	7	3
Multiple Elbows in the Same Plane		9	9	3
Multiple Elbows in Different Planes		18	9	3
Reduction in Pipe Size		8	8	3
Increase in Pipe Size		8	8	3
Control Valve		24	9	4

Table 1. Straight Run Requirements

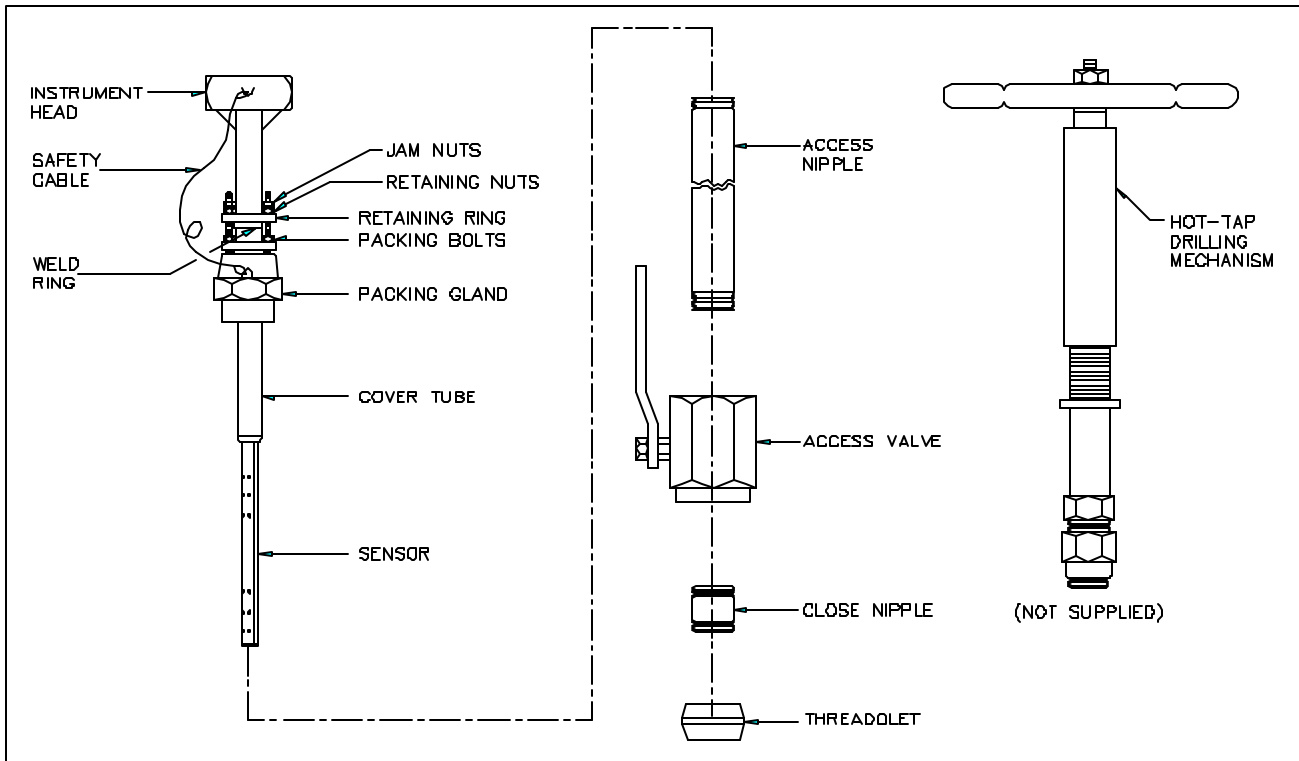


Figure 2. Verabar Model V250

4.2.2 Vertical Piping

The Verabar may be mounted in any location around the circumference of the pipe for vertical piping applications (Figure 1).

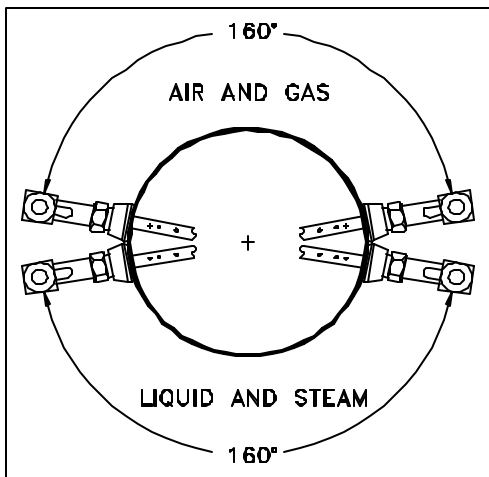


Figure 1. Verabar Orientation in Horizontal Pipe

4.3 DP Transmitter/Local Indicator Location

When choosing a Verabar location, consider the DP transmitter/local indicator location:

- The transmitter must be mounted below the Verabar for liquid and steam applications.
- The transmitter must be mounted above the Verabar for air and gas applications.

4.4 Installation Drawings and Bill of Materials

Additional information is available in the Installation Drawings and Bill of Materials VB-7061 (also on the VeraData CD). It contains standard and alternate transmitter locations and a complete bill of materials based on the fluid type and sensor orientation on the pipe.

4.5 Piping Support

For sensors that extend more than 36" (915mm) beyond the pipe wall or for sensors mounted in thin-walled pipes, external support of the Verabar is recommended. This will reduce stresses on the pipe wall.

5.0 INSTALLATION PROCEDURE

5.1 Assemble the Verabar

Your Verabar is shipped loosely assembled and is not properly tightened for proper pressure retention. Follow all assembly steps to ensure a safe installation.

5.2 Install Instrument Valves or Manifold

5.2.1 Valves

If the Verabar does not have a valve head, install instrument valves using proper thread sealant (Figure 2). Be sure instrument shut-off valves are installed and shut prior to repressurizing the pipe.

5.2.2. Manifold

If the Verabar has a direct or integral manifold, be sure the high and low pressure block valves are shut off prior to repressurizing the pipe.

5.3 Install Access Nipple

Using proper sealant, thread access nipple into packing gland (Figure 3). Note that the lower clamp ring on the access nipple is nearest the tip of the Verabar.

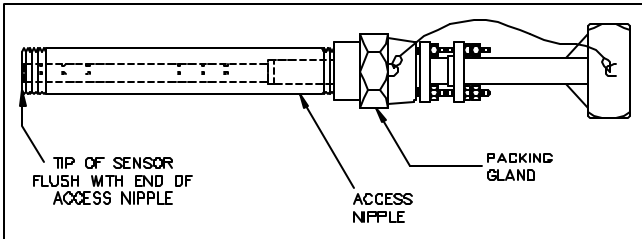


Figure 3. Thread Access Nipple into Packing Gland

5.4 Tighten Packing

Retract the Verabar such that the tip of the sensor is flush with the end of the access nipple (Figure 3). Tighten the three packing bolts on the packing gland.

5.5 Weld Threadolet to Pipe

Mark the location where the Verabar is to be mounted. Position the threadolet over the center of the mark. Using the appropriate weld gap (1/16" [1.5mm] typical), tack weld the threadolet into position. Protect threads on the threadolet, then finish welding the threadolet to the pipe per applicable codes (Figure 4).

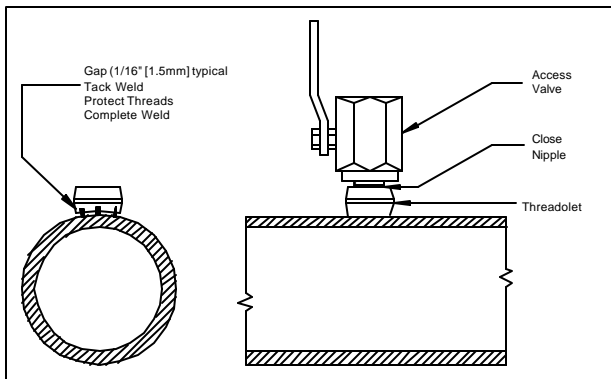


Figure 4. Weld Gap

5.6 Install Close Nipple & Access Valve

Using appropriate pipe thread sealant, install close nipple and access valve (Figure 4). Be sure the valve handle does not hit the pipe during opening and closing of the valve. Verify that the close nipple and access valve are properly tightened, because beyond this point it will not be serviceable without depressurizing the line.

5.7 Drill Hole in Pipe

- With the access valve in the full open position, install an appropriate Hot-Tap Drilling Machine (Figure 5) and drill a hole in the pipe (hole sizes per the chart below). Follow the instructions given by the Hot-Tap Drilling Machine.

Sensor Size	Hole Dia
V250-05	1/2" (13mm)
V250-10	1" (25mm)
V250-15	1-1/2" (38mm)

- After the hole has been completely drilled, retract the Hot-Tap Drilling Machine. Shut off the access valve prior to removal of the Hot-Tap Drilling Machine.

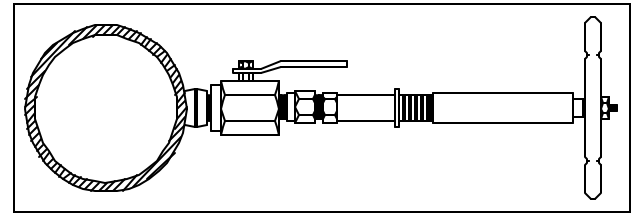


Figure 5. Hot Tap Drilling Machine

Note: There are numerous Hot Tap Drilling Machines on the market with various pressure and temperature ratings. These devices can usually be rented at a local utility company. For more information concerning Hot Tap Drilling Machines, the following companies can be contacted: Mueller Co., Decatur, IL (217) 423-4471 or T.D. Williamson, Inc., Tulsa, OK (918) 446-1941.

5.8 Mount Sensor Assembly to Access Valve

Apply appropriate thread sealant to the access nipple and thread the access nipple into the access valve. Orient the sensor such that the arrow labeled "flow" on the instrument head is in the direction of the flow in the pipe to within 3° (orientation per Figure 7).

5.9 Vent Access Valve to Verify No Leaks Are Present

With the instrument valves shut, slowly crack open the access valve and verify there are no process fluid leaks. If leaks are present, shut off the access valve and tighten the leaky joint.

5.10 Insert Sensor Assembly

- The Verabar should be oriented such that the arrow on the head is pointing in the direction of flow. Orientation of flow arrow is per (A) or (B) in Figure 7.
- Completely open the access valve.
- Attach a come-along or similar type device to the come-along ring on the instrument head (Fig. 6).
- Wrap the other end of the come-along around the circumference of the pipe and firmly secure it.
- Using the come-along or similar type device, insert the Verabar until the tip of the sensor completely bottoms on the opposite end of the pipe. Continue to insert the sensor until firm resistance is met.

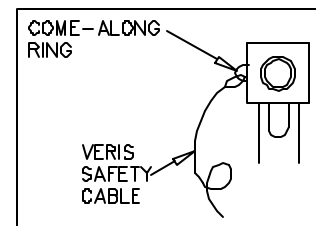


Figure 6. Come-along

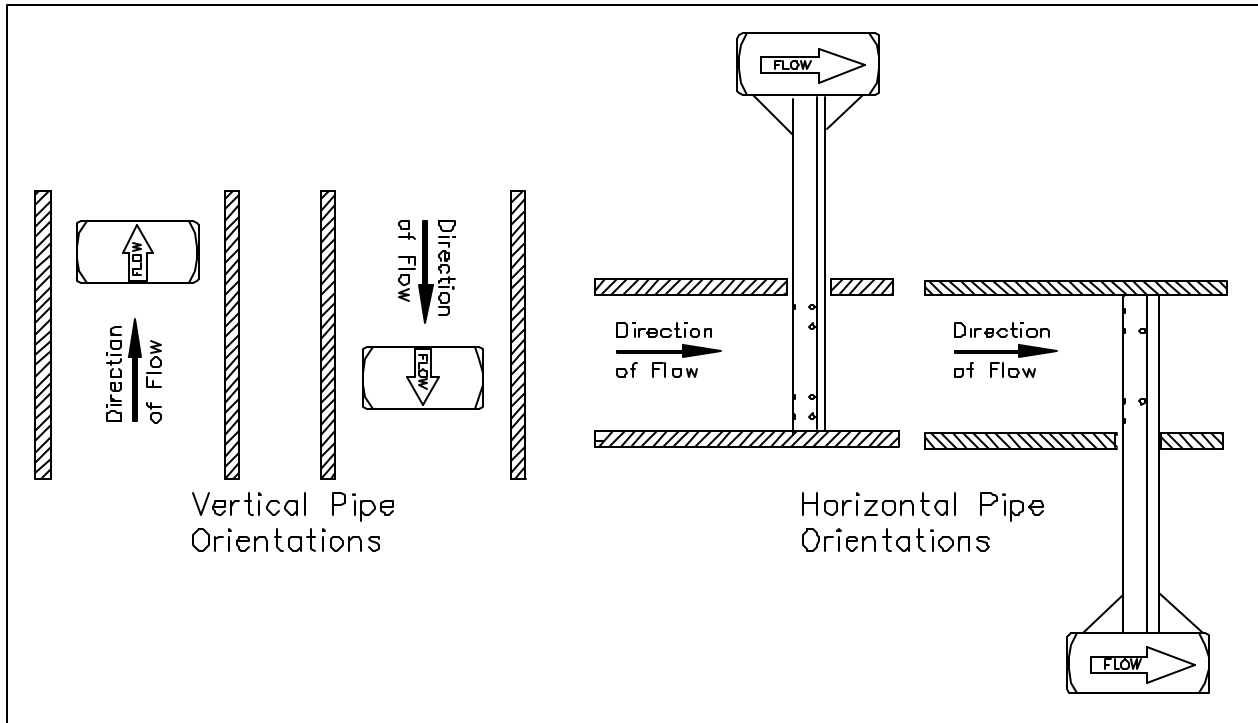


Figure 7. Orientation of Flow Arrow

- Once the sensor is completely bottomed, slide the retaining ring over the three retaining studs and tighten the retaining nuts until the ring presses firmly against the weld ring. (This will prevent the sensor tip from vibrating free from the opposite wall of the pipe). Jam nuts should now be threaded on and pressed tightly against the retaining nuts.

Warning: The retaining ring must be secured before the come-along is removed.

- At this point, the come-along can be safely removed.
- Re-verify that the orientation of the sensor is such that the arrow labeled “flow” on the instrument head is in the direction of the flow in the pipe to within 3° (Figure 7).

Warning: The retaining ring should not be removed unless a come-along is properly attached and all slack is removed from the come-along.

The Verabar is now properly installed (Figure 8).

Periodic Maintenance

The assembly should be periodically checked. Verify that no leaks are present. Tighten the packing bolts if necessary.

Sensor Removal Procedure

- Shut off instrument valves.
- Properly install a come-along and remove all slack from the come-along.
- Remove jam nuts and retaining nuts.
- Pull retaining ring off retaining studs.
- Slowly retract the come-along and do not allow more than 1/2” (13mm) of slack to develop in the

come-along during the entire retraction process. It may be necessary to assist the sensor removal by pulling on the instrument head.

- Retract the sensor until the safety cable is tight.
- Completely shut off the access valve. Slowly crack open one of the Verabar instrument valves and bleed off any remaining pressure contained in the access nipple. The sensor assembly can now be removed.

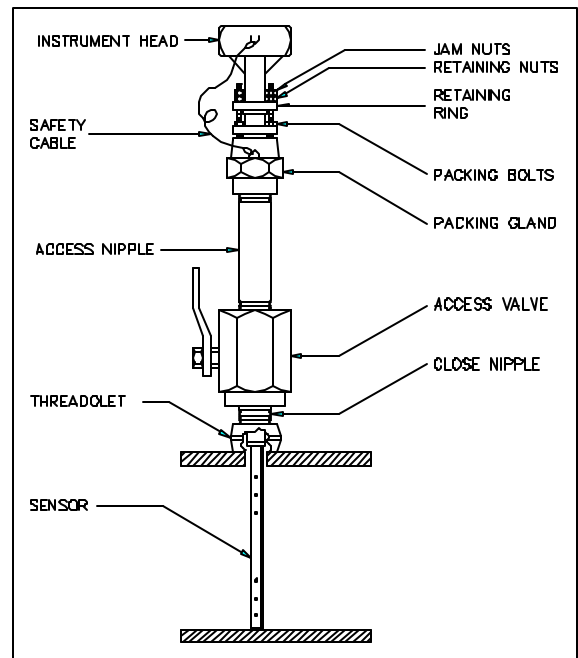


Figure 8. Installed V250