

Data Sheet

ECLIPSE[®]

Enhanced Model 705 GWR Level Transmitter
for Hygienic Applications

Registered Address

ABLE Instruments & Controls Ltd
Cutbush Park, Danehill, Lower Earley,
Reading, Berkshire, RG6 4UT. UK.

Reading

Tel: +44 (0)118 9311188 | Email: info@able.co.uk

Aberdeen

Tel: +44 (0)1224 725999 | Email: ab@able.co.uk

Web

able.co.uk

E-commerce

247able.com



Registered in England No. 01851002. VAT No. GB 417 2481 61



Eclipse® Enhanced Model 705 GWR Level Transmitter for Hygienic Applications

DESCRIPTION

The Enhanced Eclipse® Model 705 is a loop-powered, 24 VDC, level transmitter based upon the revolutionary Guided Wave Radar (GWR) technology. This transmitter offers enhanced reliability, as demonstrated by a Safe Failure Fraction of 91% (suitable for SIL2 applications).

This ECLIPSE transmitter is designed to provide measurement price/performance well beyond that of all traditional technologies.

ECLIPSE supports the FDT/DTM standard and a PACTware™ PC software package allows for additional configuration and trending flexibility.

TECHNOLOGY

ECLIPSE Guided Wave Radar is based upon the technology of TDR (Time Domain Reflectometry). TDR utilizes pulses of electromagnetic energy transmitted down a probe. When a pulse reaches a surface that has a higher dielectric than the air/vapor in which it is traveling, the pulse is reflected. Ultra high-speed timing circuit precisely measures the transit time and provides an accurate level measurement.

ECLIPSE GWR can be utilized to detect overall level or interface level, and when used with a HART® splitter, it can transmit two 4–20 mA signals.

APPLICATIONS

MEDIA: Liquids or slurries; hydrocarbons to water-based media (dielectric 1.9–100).

VESSELS: Most process or storage vessels, up to rated probe temperature and pressure.

CONDITIONS: Virtually all level measurement and control applications including process conditions exhibiting visible vapors, foam, coating/buildup, surface agitation, bubbling or boiling, high fill/empty rates, low level and varying dielectric media or specific gravity.



BPE



FEATURES

- Two-wire, 24 VDC, loop-powered transmitter for level, interface, or volume
- HART®, FOUNDATION fieldbus™ or PROFIBUS PA digital communications
- Performance not process dependent (changing specific gravity and dielectric constant have no significant effect)
- Designed to BPE Standards
- No level change needed for configuration; no field calibration necessary
- 20-point custom strapping table for volumetric or flow measurement
- Can measure reliably to very top of vessel and to the bottom of the probe
- Probes available in 316L SS, AL6XN and Hastelloy® C22 (15Ra MAX electropolished probe rod finish)
- Standard C of C documentation included. (The C of C includes certification of o-rings, PTFE, and PEEK as 21CFR-177 GRAS and USP <88> Class VI at 121 °C, and metallic material CMTRs and surface finish specification.)
- IS, XP, and Non-Incendive approvals
- Two-line, 8-character LCD and 3-button keypad (opt.)
- Quick connect/disconnect probe coupling
- Third Party Safety Integrity Level (SIL) data (FMEDA analysis) for Safety Instrument Systems engineering is available. (HART® version.)

TRANSMITTER SPECIFICATIONS

FUNCTIONAL / PHYSICAL

Signal output		4–20 mA with HART, 3.8 to 20.5 mA usable (meets NAMUR NE 43) FOUNDATION fieldbus™ H1(ITK4.6) (optional) PROFIBUS PA (optional)
Span		6 inches to 20 feet (15 to 610 cm)
Resolution	Analog Display	0.01 mA 0.1 inches or cm
Loop resistance		630 Ω @ 24 VDC (20.5 mA)
Damping		Adjustable 0–10 seconds
Diagnostic alarm		Adjustable 3.6 mA, 22 mA, or HOLD
User interface		3-button keypad, HART communicator, FOUNDATION fieldbus™, PROFIBUS
Display		2-line × 8-character LCD
Power (at terminals)		
General purpose/Intrinsically safe		11 to 36 VDC
Explosion proof (with intrinsically safe probe)		11 to 36 VDC
FOUNDATION fieldbus/PROFIBUS PA: General Purpose/XP		9 to 32 VDC
FOUNDATION fieldbus/PROFIBUS PA: IS/Fisco		9 to 30 VDC
Menu language		English, Spanish, French and German
Housing material		304 stainless steel deep drawn Aluminum A356T6 (< 0.2% copper) (optional)
Net/Gross weight	304 stainless steel Aluminum	3 lbs (1.36 kg) / 4 lbs (1.81 kg) 6 lbs (2.72 kg) / 7 lbs (3.18 kg)
Overall dimensions	304 stainless steel Aluminum	H 4.5" (114mm) x W 3.0" (76mm) H 8.43" (214 mm) x W 4.38" (111 mm) x D 7.40" (188 mm)



PERFORMANCE

Reference conditions	Reflection from water at +70 °F (+20 °C) with 72" (1.8 m) single rod probe in metal vessel (CFD threshold)
Linearity ①	< 0.1% of probe length or 0.1 inch (3 mm) (whichever is greater)
Measured error ①	±0.1% probe length or ±0.1 inch (3 mm) maximum
Resolution ②	±0.1 inch (1 mm)
Repeatability ②	< 0.1 inch (±0.025% of Volume)
Hysteresis ②	< 0.1 inch (1 mm)
Response time	< 1 second
Warm-up time	< 5 seconds
Operating temperature range	-40 to +175 °F (-40 to +80 °C)
LCD readable temperature range	-5 to +160 °F (-20 to +70 °C)
Operating temperature effect	±0.02% of probe length / °C
Humidity	0-99%, non-condensing
Electromagnetic compatibility	Meets CE requirements (EN 61000-6-2/2001, EN 61000-6-4/2001) (Probes must be used in metallic vessel to maintain CE compliance)
SIL 2 (optional)	Safe Failure Fraction (SFF) 91%

① Specification for top 12 inches of single rod probe will be application dependent.

② When used with strapping table

AGENCY APPROVALS

AGENCY	MODEL APPROVED	APPROVAL CATEGORY	APPROVAL CLASSES
	705-5XXX-1XX 705-5XXX-2XX	Intrinsically Safe ①	Class I, Div. 1; Groups A, B, C, & D Class II, Div. 1; Groups E, F, & G T4 Class III, Type 4X, IP66 Entity
	705-5XXX-3XX 705-5XXX-4XX	Explosion Proof ② (with Intrinsically Safe probe)	Class I, Div. 1; Groups B, C & D Class II, Div. 1; Groups E, F, & G T4 Class III, Type 4X, IP66
	705-5XXX-XXX 705-5XXX-XXX	Non-Incendive Suitable for: ③	Class I, Div. 2; Groups A, B, C, & D Class II, Div. 2; Groups F & G T4 Class III, Type 4X, IP66
	705-5XXX-1XX 705-5XXX-2XX	Intrinsically Safe	Class I, Div. 1; Groups A, B, C, & D Class II, Div. 1; Group E, F & G T4 Class III, Type 4X Entity
	705-5XXX-3XX 705-5XXX-4XX	Explosion Proof ② (with Intrinsically Safe probe)	Class I, Div. 1; Groups B, C & D Class II, Div. 1; Group E, F & G T4 Class III, Type 4X
	705-5XXX-XXX 705-5XXX-XXX	Non-Incendive Suitable for: ③	Class I, Div. 2; Groups A, B, C, & D Class II, Div. 2; Group E, F & G T4 Class III, Type 4X
IEC	705-5XXX-AXX 705-5XXX-BXX	Intrinsically Safe ④	Zone 0 Ex ia IIC T4
	705-5XXX-AXX 705-5XXX-BXX	Intrinsically Safe ④	Ⓜ II 1G, EEx ia IIC T4
	705-5XXX-CXX 705-5XXX-DXX	Flame Proof	Ⓜ II 1/2G, EEx d [ia] IIC T6
	705-51XX-EXX 705-51XX-FXX	Non-sparking	Ⓜ II 3(1)G, EEx nA [ia] IIC T4..T6 with probe II 1 G EEx ia IIC T6
	705-52XX-EXX 705-52XX-FXX		Ⓜ II 3(1)G, EEx nA [nL] [ia] IIC T4..T6 with probe II 1 G EEx ia IIC T6



These units are in conformity of:

1. The EMC Directive: 2004/108/EC. The units have been tested to EN 61326.
2. Directive 94/9/EC for equipment or protective system for use in potentially explosive atmospheres.

Note: Single and twin rod probes must be used in metallic vessel or stillwell to maintain CE compliance.

- ① Hygienic enclosure is an “end of line” device. Enclosure contains a single conduit entry. Second conduit entry is plugged and sealed.
- ② Factory Sealed: This product has been approved by Factory Mutual Research (FM), and Canadian Standards Association (CSA), as a Factory Sealed device.
- ③ **IMPORTANT:** Measured media inside vessel must be non-flammable only. If media inside vessel is flammable, then the explosion proof version (which contains an internal barrier making the probe Intrinsically Safe) is required.
- ④ **Special conditions for safe use**
Because the enclosure of the Guided Wave Radar Level Transmitter ECLIPSE Model 705-5____-1____ and/or Probe ECLIPSE Model 7____-____-____ is made of aluminum, if it is mounted in an area where the use of category 1 G (Zone 0) apparatus is required, it must be installed such, that, even in the event of rare incidents, ignition sources due to impact and friction sparks are excluded.

For applications in explosive atmospheres caused by gases, vapours or mists and where category 1G (Zone 0) apparatus is required, electrostatic charges on the non-metallic parts of the Probe ECLIPSE Model 7x5-____-____, Model 7x7-____-____ and Model 7_F-____-____ shall be avoided.

PACTWARE PC SOFTWARE PROGRAM

PACTware PC software and the new Field Device Tool (FDT) standard take radar level measurement to a new level of setup efficiency and user-friendliness. The powerful ECLIPSE guided wave radar transmitter with its linear program has always been easy to use. PACTware builds on that ease of use by adding a graphical software interface. Simply connect your PC through a serial interface to the HART loop and all functionality can be accessed quickly, conveniently, and safely.

Refer to PACTware bulletins 59-101 and 59-601 for more information.

PACTware offers distinct advantages in loop tuning and configuration documentation.



PROBE OVERVIEW

SINGLE ROD PROBES

The pulses of energy from a single rod probe develop between the center rod and the mounting nut or flange. In other words the pulse propagates down the rod as it references its ground at the top of the tank. The efficiency of the pulse “launch” is directly related to how much metallic surface exists around it at the top of the vessel.

Figure 1 shows the single element design and how the pulse expands into a teardrop shape as it propagates away from the top of the tank (ground reference). Because the design is “open,” it is the most forgiving of coating and buildup. It is important to note that a parallel metal wall INCREASES its performance while a singular, metal object protruding near the probe may be improperly detected as a liquid level.

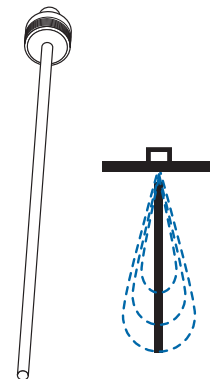

Figure 1
Single Rod Probe

PROBE OVERVIEW (cont.)

NOZZLES

The 7xF and 7xH Single Rod probes may be susceptible to objects that are in close proximity. The following rules should be followed for proper application:

1. Nozzle must be $\frac{3}{4}$ " (19 mm) diameter (A) or larger.
2. Ratio of diameter (A) to length (B) is 1:1 or greater. Any ratio < 1:1 (e.g., a 2" x 6" nozzle = 1:3) can be used but may require a BLOCKING DISTANCE and/or SENSITIVITY adjustment. See Figure 2.
3. Pipe reducers that create restriction should not be used. See Figure 3.

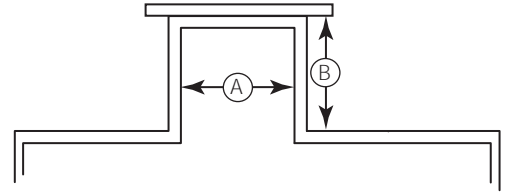

Figure 2

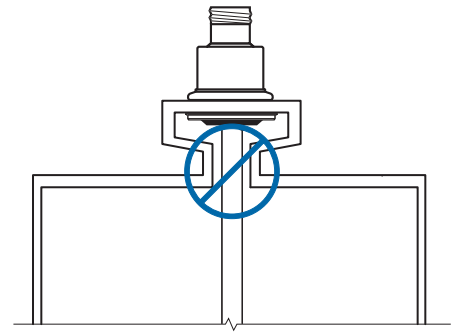

Figure 3

OBSTRUCTIONS (METALLIC)

1. If PACTware is used for loop tuning, objects (e.g., shoulders or agitator blades) can be within $\frac{1}{4}$ " of probe.

TURBULENCE

The bottom of a single rod probe should be stabilized if turbulence will cause a deflection of more than 3 inches (80 mm) at 10 feet (3 m) of length. A metallic capture ring can be employed at the bottom of the probe to eliminate torque buildup.

Obstructions (Metallic) – Guidelines

Distance to probe	Acceptable objects
< 0.5" (13 mm)	Continuous, smooth, parallel, conductive surface (e.g., tank wall); probe should not touch tank wall

Figure 4

PROCESS SEAL TEMPERATURE/PRESSURE CHART

Note: Tri-clamp connection service rating may further limit pressure.

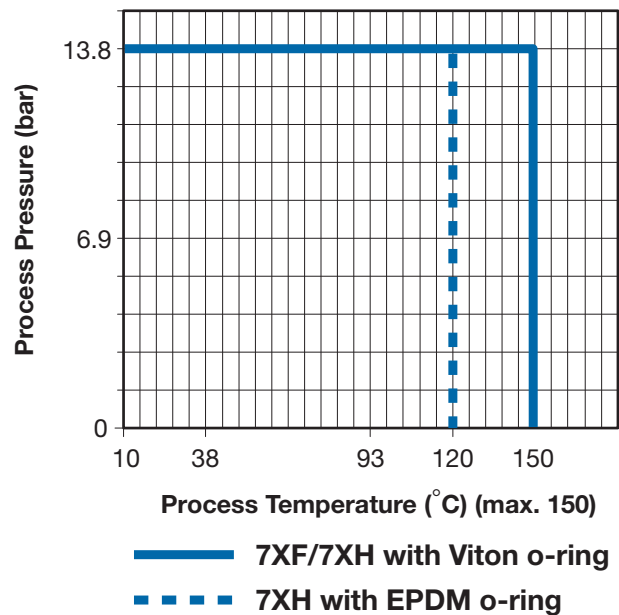
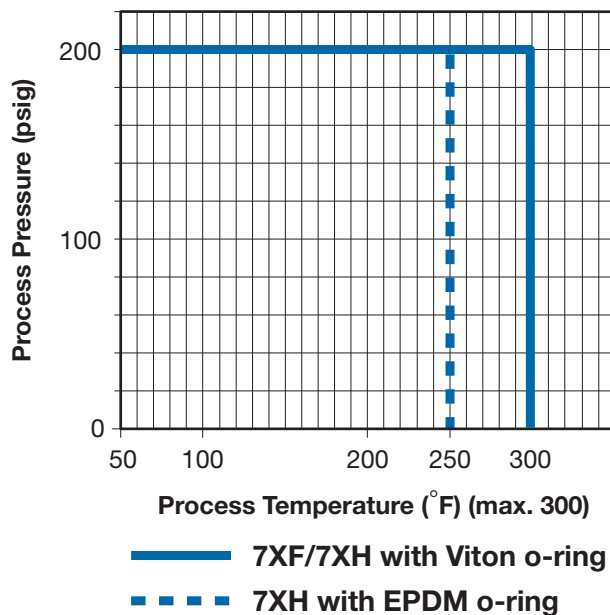

PROBE & HOUSING FEATURES



Stainless Steel Housing with Model 7xH Hygienic probe

ECLIPSE Model 705 transmitter in a 304 SS housing for use in a variety of hygienic applications. 0.5-inch diameter 316L SS probe with a 15Ra MAX surface finish is available with lengths up to 244" and with Tri-Clover® type connection sizes from 1" through 4".

In addition, a 0.25-inch diameter 316L SS probe with 15Ra MAX surface finish is available with lengths up to 72" and with a 3/4" Tri-Clover® type connection.

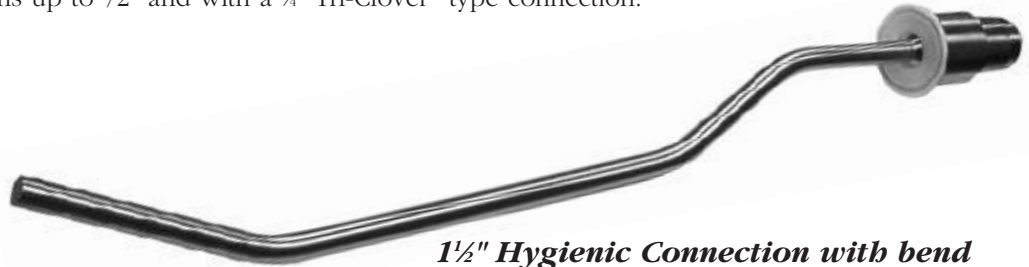

1 1/2" Hygienic Connection with bend

316L SS probes can be bent to avoid internal obstructions such as agitator blades and spray balls, and to ensure lowest possible level detection.



3/4" Hygienic Connection without bend

0.25-inch diameter probes suitable for use in smaller vessels where space is at a premium. Available in lengths up to 72 inches.



Segmented Hygienic Probe

Segmented probes are available should the probe be inserted or removed with limited headroom above the vessel (segmented lengths are specified by the customer). Contact the factory for details.

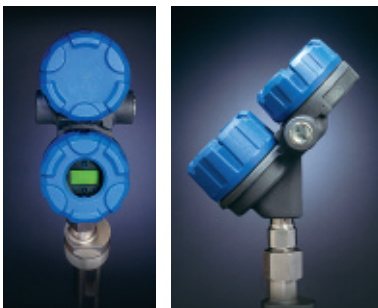

Aluminum Dual Compartment Housing

ECLIPSE Model 705 transmitter is available with an industrial dual compartment aluminum housing.

REMOTE ASSEMBLY INCHES (MM)

The Local/Remote assembly is meant to be a simple and cost-effective way to remove the transmitter electronics and locate it a short distance away from the probe. The assembly allows a remote distance of 33" (84 cm) or 144" (3650 cm) which offers a greater degree of flexibility during installation. It is supplied with a remote bracket and flexible armor conduit as a complete assembly. This can be employed with both styles of housings.

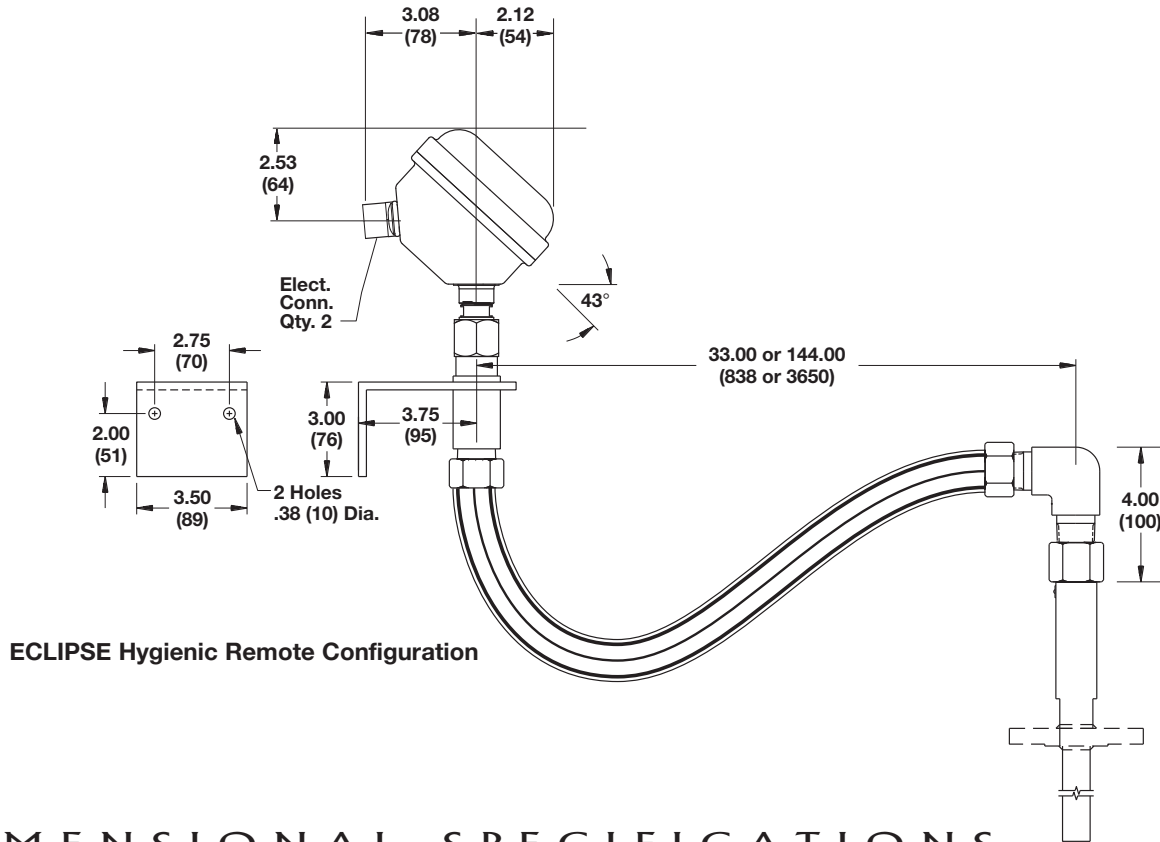

ECLIPSE Hygienic Remote Configuration

DIMENSIONAL SPECIFICATIONS INCHES (MM) – SINGLE ROD PROBES

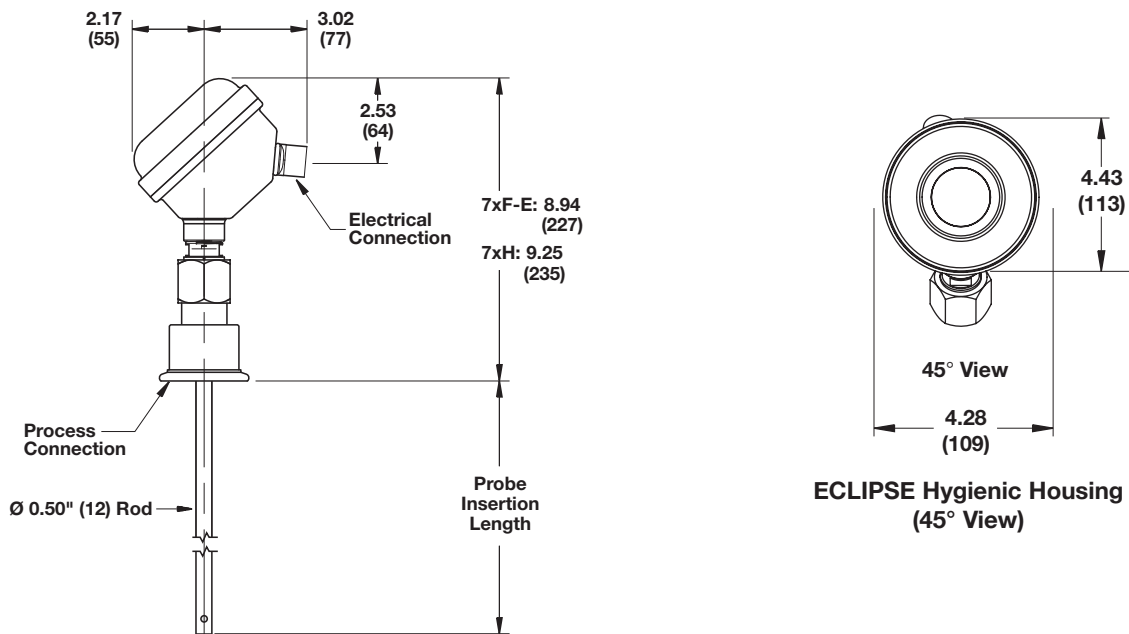

ECLIPSE Hygienic Housing (shown with 7xF-E Hygienic Probe)

SINGLE ROD PROBE MATRIX

7xF-E, -F, -G and 7xH Hygienic

BPE



Recommended For	Applications demanding hygienic specifications
Not Recommended For	Low dielectric media ($\epsilon_r < 1.9$)
Materials/Wetted Metallic Parts	7EF: 316L SS, <15 R _a electropolished finish (Optional: Hastelloy C, AL6XN SS) 7EH: 316L SS, <15 R _a electropolished finish (Optional: Hastelloy C, AL6XN SS)
Elastomer and Polymeric Wetted Parts	7EF: PTFE (GRAS 21CFR177-1550 and USP <88> Class VI at 121 °C) 7EH: PEEK and O-ring (Viton or EPDM) (GRAS 21CFR177 and USP <88> Class VI at 121 °C)
Diameter	∅.50 (13 mm) rod for process connections > ¾" (24–240 inches) ∅.25 (7 mm) for process connections = ¾" (24–72 inches)
Flange ANSI (DIN)	¾ to 4" (38 to 100 cm); Tri-Clamp® fitting
Length ①	24 to 240" (60 to 610 cm) for Tri-Clamp process connections equal to 1" or greater 24 to 72" (61 to 183 cm) for ¾" Tri-Clamp type process connection
Transition Zone	
Top	1" (25 mm) @ $\epsilon_r > 10$
Bottom	1" (25 mm) @ $\epsilon_r > 10$
Blocking Distance	
Top	0–36" (0–91cm) probe length/application dependent
Process Temperature ② (Max.)	+300 °F @ 200 psig (+150 °C @ 13.8 bar)
Min. (Cryogenic)	Consult factory
Process Pressure Max.	200 psig @ +300 °F (13.8 bar @ +150 °C) or limit of tri-clamp service rating, whichever is lower
Min. (Vacuum Service)	N/A
Dielectric ③	1.9 to 100
Max. Viscosity (cP)	10,000 (consult factory if severe agitation/turbulence)
Mounting Effects	See Nozzles and Obstructions on page 5
Coating/Buildup	Yes; maximum error 10% of coated length; % of coated length; % error related to dielectric of media, thickness of coating & coated probe length above media
Foam	Yes
Corrosives	Yes
Hygienic	Yes
Overfill	No
Approvals	
FM	Yes
CSA	Yes
ATEX	Yes
OTHER	No

① Contact factory for applications requiring probe lengths less than 24" (60 cm).

② Refer to Process Temperature vs. Process Pressure Graph

③ ϵ_r 1.9–10 must be mounted between 2–6" (50–150 mm) of metal tank wall.

TYPICAL HYGIENIC APPLICATIONS

The Model 705 transmitters are presently installed in a variety of media systems including bioreactors, fermentors, media storage, crystallizers, decanters, ultra filtration skid receivers, cook kettles, CIP systems, balance tanks, mixing tanks, storage tanks, etc.

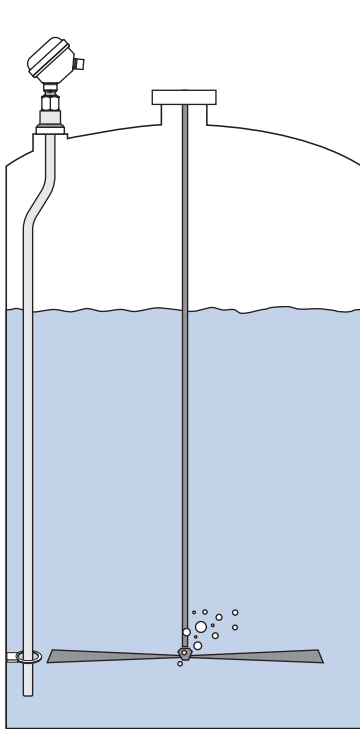

25K Liter Reactor

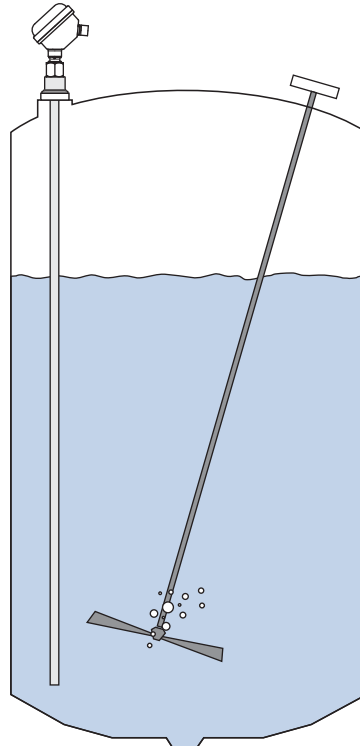

**1500K Liter Fermentor
or Mix Tank**

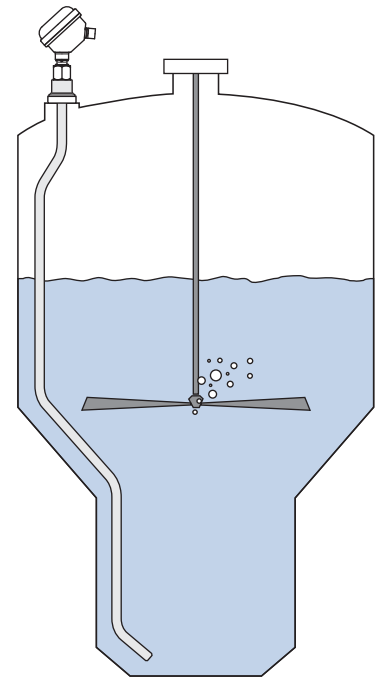

Tulip Tank

***Buffer systems, Media Systems
and Filtration including:***

- primary mix tanks
- hold tanks
- day tanks
- bulk tanks

CIP systems including:

- wash and rinse tanks
- bulk tanks
- skid delivery tanks

Utility systems including:

- ammonia storage
- CO₂ storage
- inlet water
- deaerator systems
- condensate receivers
- boiler drums
- fuel oil storage
- various sumps
- waste tanks
- neutralization tanks
- kill vessels

MODEL NUMBER

TRANSMITTER

 Models available for quick shipment, usually within one week after factory receipt of a complete purchase order, through the Expedite Ship Plan (ESP).

BASIC MODEL NUMBER

705	ECLIPSE Guided Wave Radar Level Transmitter
-----	---

POWER

5	24 VDC, Two-wire
---	------------------

SIGNAL OUTPUT

1	4–20 mA with HART
2	FOUNDATION fieldbus™ Digital Communication (English only)
3	PROFIBUS PA Digital Communication (English Only)

OPTIONS

0	None – SIL 1 Standard Electronics (SFF=84.5%)
A	SIL 2 (Certified) Enhanced Electronics (SFF=91%) ①

ACCESSORIES

0	Digital display and keypad with blind cover
A	Digital display and keypad with window cover

MOUNTING/CLASSIFICATION

1	Integral, General Purpose & Intrinsically Safe (FM & CSA), Non-incendive (Class I, Div. 2)
2	3-foot Remote, General Purpose & Intrinsically Safe (FM & CSA), Non-incendive (Class I, Div. 2)
3	Integral, Explosion Proof (FM & CSA) & Non-incendive
4	3-foot Remote, Explosion Proof (FM & CSA) & Non-incendive
A	Integral, General Purpose & Intrinsically Safe (ATEX & JIS EEx ia IIC T4)
B	3-foot Remote, General Purpose & Intrinsically Safe (ATEX & JIS EEx ia IIC T4)
C	Integral, Explosion Proof (ATEX EEx d [ia] IIC T6) (must be ordered with Conduit Connection Codes 0 and 1)
D	3-foot Remote, Explosion Proof (ATEX EEx d [ia] IIB T6) (must be ordered with Conduit Connection Codes 0 and 1)
E	Integral, Non-incendive (ATEX EEx n II T4..6)
F	3-foot Remote, Non-incendive (ATEX EEx n II T4..6)

HOUSING

1	Cast aluminum, dual compartment, 45° angle
2	316L stainless steel, dual compartment, 45° angle
3	304 stainless steel, single compartment ②
7	Cast aluminum, dual compartment, 12-foot remote
8	316L stainless steel, dual compartment, 12-foot remote
9	304 stainless steel, single compartment, 12-foot remote ②

CONDUIT CONNECTION

0	¾" NPT
1	M20
4	½" NPT ③

- ① Not available with Model 7xH Probe
- ② Not available with conduit connection code 0
- ③ Not available with explosion proof Mounting/Classification codes 3, 4, C, D.



MODEL NUMBER

PROBE

BASIC MODEL NUMBER

7E	ECLIPSE GWR probe, English unit of measure
7M	ECLIPSE GWR probe, Metric unit of measure

CONFIGURATION/STYLE

F	Hygienic Single Rod (with PTFE seal)
H	Hygienic Single Rod (with O-Ring seal)

MATERIAL OF CONSTRUCTION

E	Hygienic, 316L stainless steel (15 R _a EP finish)
G	Hygienic, AL6XN stainless steel (15 R _a EP finish)
H	Hygienic, Hastelloy C22 (15 R _a EP finish)

PROCESS CONNECTION SIZE/TYPE

HYGIENIC FLANGE CONNECTIONS

2P	3/4" Tri-Clover® type, 16 AMP Hygienic Flange (only available with 3rd digit F)
3P	1" or 1½" Tri-Clover® type, 16 AMP Hygienic Flange
4P	2" Tri-Clover® type, 16 AMP Hygienic Flange
5P	3" Tri-Clover® type, 16 AMP Hygienic Flange
6P	4" Tri-Clover® type, 16 AMP Hygienic Flange
9P	2½" Tri-Clover® type, 16 AMP Hygienic Flange

O-RINGS

1	EPDM (only available with 3rd digit H)
C	Viton® GF (only available with 3rd digit H)
N	None (only available with 3rd digit F)

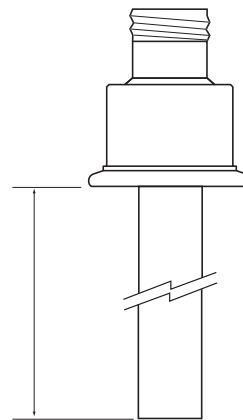

Insertion Length
Hygienic Flange

LENGTH

24 to 240 inches (60 to 610 cm) ① (unit of measure is determined by second digit of Model Number) Examples: 24 inches = 024; 60 centimeters = 060

① Contact factory for applications requiring probe lengths less than 24" (60 cm).



QUALITY



The quality assurance system in place at Magnetrol® guarantees the highest level of quality throughout the company. MAGNETROL is committed to providing full customer satisfaction both in quality products and quality service.

The MAGNETROL quality assurance system is registered to ISO 9001 affirming its commitment to known international quality standards providing the strongest assurance of product/service quality available.

ESP

Expedite Ship Plan

Several Models of ECLIPSE Guided Wave Radar Transmitters are available for quick shipment, usually within one week after factory receipt of a complete purchase order, through the Expedite Ship Plan (ESP). Models covered by ESP service are color coded in the selection data charts.

To take advantage of ESP, simply match the color coded model number codes (standard dimensions apply).

ESP service may not apply to orders of ten units or more. Contact your local representative for lead times on larger volume orders, as well as other products and options.

WARRANTY



All MAGNETROL electronic level and flow controls are warranted free of defects in materials or workmanship for eighteen months from the date of original factory shipment.

If returned within the warranty period; and, upon factory inspection of the control, the cause of the claim is determined to be covered under the warranty; then, MAGNETROL will repair or replace the control at no cost

to the purchaser (or owner) other than transportation.

MAGNETROL shall not be liable for misapplication, labor claims, direct or consequential damage or expense arising from the installation or use of equipment. There are no other warranties expressed or implied, except special written warranties covering some MAGNETROL products.

For additional information, see Instruction Manual 57-600.

ECLIPSE Guided Wave Radar transmitters may be protected by one or more of the following U.S. Patent Nos. US 6,062,095; US 6,247,362; US 6,588,272; US 6,626,038; US 6,640,629; US 6,642,807; US 6,690,320; US 6,750,808; US 6,801,157. May depend on model.



705 Enterprise Street • Aurora, Illinois 60504-8149 • 630.969.4000
info@magnetrol.com • magnetrol.com

Copyright © 2019 Magnetrol International, Incorporated.

Performance specifications are effective with date of issue and are subject to change without notice.

Magnetrol, Magnetrol logotype and Eclipse are registered trademarks of Magnetrol International, Incorporated.

HART® is a registered trademark of the HART Communication Foundation.

Hastelloy® is a registered trademark of Haynes International.

Monel® is a registered trademark of the INCO family of companies.

PEEK™ is a trademark of Vitrex plc.

Teflon® is a registered trademark of DuPont.

Tri-Clamp is a registered trademark of Ladish Co.

Tri-Clover® is a registered trademark of Tri-Clover, Inc.

Viton® and Kalrez® are registered trademarks of DuPont Performance Elastomers.

BULLETIN: 57-110.12

EFFECTIVE: May 2019

SUPERSEDES: March 2017