



Installation & Maintenance Instructions 12/2013

# SITRANS Probe LU (HART)

Ultrasonic Transmitter



**Safety Guidelines:** Warning notices must be observed to ensure personal safety as well as that of others, and to protect the product and the connected equipment. These warning notices are accompanied by a clarification of the level of caution to be observed.

**Qualified Personnel:** This device/system may only be set up and operated in conjunction with this manual. Qualified personnel are only authorized to install and operate this equipment in accordance with established safety practices and standards.

**Unit Repair and Excluded Liability:**

- The user is responsible for all changes and repairs made to the device by the user or the user's agent.
- All new components are to be provided by Siemens Milltronics Process Instruments.
- Restrict repair to faulty components only.
- Do not reuse faulty components.

**Warning:** Cardboard shipping package provides limited humidity and moisture protection. This product can only function properly and safely if it is correctly transported, stored, installed, set up, operated, and maintained.

**This product is intended for use in industrial areas. Operation of this equipment in a residential area may cause interference to several frequency based communications.**

**Note:** Always use product in accordance with specifications.

**Copyright Siemens AG 2013. All Rights Reserved**

**Disclaimer of Liability**

This document is available in bound version and in electronic version. We encourage users to purchase authorized bound manuals, or to view electronic versions as designed and authored by Siemens Milltronics Process Instruments. Siemens Milltronics Process Instruments will not be responsible for the contents of partial or whole reproductions of either bound or electronic versions.

While we have verified the contents of this manual for agreement with the instrumentation described, variations remain possible. Thus we cannot guarantee full agreement. The contents of this manual are regularly reviewed and corrections are included in subsequent editions. We welcome all suggestions for improvement.

Technical data subject to change.

MILLTRONICS® is a registered trademark of Siemens Milltronics Process Instruments.

**Contact SMPI Technical Publications**

**at the following address:**

Technical Publications  
Siemens AG  
Siemens Milltronics Process Instruments  
1954 Technology Drive, P.O. Box 4225  
Peterborough, Ontario, Canada, K9J 7B1  
Email: [techpubs.smpi@siemens.com](mailto:techpubs.smpi@siemens.com)

**European Authorized Representative**

Siemens AG  
Industry Sector  
76181 Karlsruhe  
Deutschland

- For a selection of Siemens Milltronics level measurement manuals, go to: **[www.siemens.com/processautomation](http://www.siemens.com/processautomation)**. Under Process Instrumentation, select *Level Measurement* and then go to the manual archive listed under the product family.
- For a selection of Siemens Milltronics weighing manuals, go to: **[www.siemens.com/processautomation](http://www.siemens.com/processautomation)**. Under Weighing Technology, select *Continuous Weighing Systems* and then go to the manual archive listed under the product family.

# Table of Contents

---

<b>Table of Contents</b> .....	<b>i</b>
Safety Notes	
Safety marking symbols .....	1
The Manual .....	1
Application Examples .....	2
Abbreviations and Identifications .....	2
<b>SITRANS Probe LU (Ultrasonic)</b> .....	<b>4</b>
Applications .....	4
Level, volume or flow .....	4
SITRANS Probe LU System Implementation .....	5
Programming .....	5
SITRANS Probe LU Approvals and Certificates .....	5
<b>Specifications</b> .....	<b>6</b>
SITRANS Probe LU .....	6
Power .....	6
Performance.....	6
Interface .....	7
Programmer (infrared keypad) .....	7
Mechanical.....	7
Environmental .....	8
Process.....	8
Approvals (verify against device nameplate).....	9
<b>Installation</b> .....	<b>11</b>
Mounting Instructions .....	12
SITRANS Probe LU Dimensions .....	13
Flange Adaptor (optional) .....	13
<b>Wiring</b> .....	<b>14</b>
Power .....	14
Connecting the SITRANS Probe LU .....	14
<b>Operating the SITRANS Probe LU</b> .....	<b>16</b>
RUN Mode .....	16
Display .....	16
PROGRAM Mode .....	17
Programming .....	17
Display .....	17

Low temperature effects on RUN/PROGRAM modes .....	18
Security .....	19
Starting PROGRAM mode .....	19
Handheld programmer .....	19
Activating SITRANS Probe LU .....	19
Accessing a parameter .....	20
Changing a Parameter Value .....	20
Master Reset (P999) .....	21
Using Units or Percent (%) .....	21
Setup Steps (outline) .....	21
Setup Instructions .....	22
Additional Settings .....	27
<b>Notes .....</b>	<b>28</b>
<b>Parameter Reference .....</b>	<b>29</b>
Helpful Hints .....	29
To access a parameter and change a value (primary index): .....	29
To access a secondary index and change a value: .....	30
Quick Start (P001 to P010).....	31
Volume (or Flow) P050 to P055 .....	34
Lock (P069).....	42
Failsafe (P070 to P073) .....	42
mA Output (P201 to P215).....	43
Installation Records (P300 to P346) .....	46
Range Calibration (P650 to P654) .....	48
Temperature Compensation (P660 to P664) .....	51
Rate (P700 and P701).....	52
Measurement Verification (P709 to P713).....	53
P752 HART address .....	55
Communications (P799).....	56
Echo Processing (P800 to P825) .....	56
Algorithm (P820) .....	59
TVT (Time Varying Threshold) Adjustment Parameters (P830 to P839) .....	60
Diagnostic Tests (P900 to P924) .....	63
Measurement .....	64

<b>Appendix A: Alphabetical Parameter List .....</b>	<b>67</b>
<b>Appendix B: Programming Chart .....</b>	<b>70</b>
<b>Appendix C: HART Communications .....</b>	<b>73</b>
HART Electronic Device Description (EDD) .....	73
HART Communicator 275/375: .....	74
SIMATIC Process Device Manager (PDM): .....	77
Maintenance settings (accessible via PDM only) .....	77
HART Version .....	78
Burst mode .....	78
Multidrop Configuration .....	78
<b>Appendix D: Troubleshooting .....</b>	<b>79</b>
Communication Troubleshooting .....	79
Generally: .....	79
Specifically: .....	79
General Fault Code .....	80
Operation Troubleshooting .....	83
<b>Appendix E: Maintenance .....</b>	<b>84</b>
Unit Repair and Excluded Liability .....	84
<b>Appendix F: Technical References .....</b>	<b>85</b>
Principles of operation .....	85
Blanking Distance .....	85
TVT (Time Varying Threshold) curves .....	85
Auto False-Echo Suppression .....	85
Open Channel Monitoring (OCM) .....	87
Failsafe .....	87
Chemical compatibility .....	88
Startup Behavior .....	88
<b>Appendix G: Hazardous area installations .....</b>	<b>89</b>
Wiring Details .....	89
Intrinsically Safe Model .....	89
FM/CSA .....	90
EU Equivalency .....	90
Loop Voltage versus Loop Resistance .....	91
IS Safety Barrier Selection .....	91
How to select a passive barrier for SITRANS Probe LU .....	91
PLC Input Modules.....	92
Passive Shunt Diode Barriers .....	92
Active barriers (repeating barriers).....	92

FM Intrinsically safe connection drawing .....	95
CSA Intrinsically Safe connection drawing .....	96
.....	96
FM Class 1, Div. 2 connection drawing .....	97
<b>Appendix H: Firmware Revision History .....</b>	<b>98</b>
<b>Glossary .....</b>	<b>99</b>
<b>Index .....</b>	<b>103</b>

## Safety Notes

Special attention must be paid to warnings and notes highlighted from the rest of the text by grey boxes.





**WARNING:** relates to a caution symbol on the product, and means that failure to observe the necessary precautions can result in death, serious injury, and/or considerable material damage.



**WARNING<sup>1</sup>:** means that failure to observe the necessary precautions can result in death, serious injury, and/or considerable material damage

**Note:** means important information about the product or that part of the operating manual.

## Safety marking symbols

In manual:	On product:	Description
		(Label on product: yellow background.) <b>WARNING:</b> refer to accompanying documents (manual) for details.

## The Manual

### Notes:

- Please follow the installation and operating procedures for a quick, trouble-free installation and to ensure the maximum accuracy and reliability of your SITRANS Probe LU.
- This product is intended for use in industrial areas. Operation of this equipment in a residential area may cause interference to several frequency based communications.
- This manual applies to the SITRANS Probe LU (HART) only.

This manual will help you set up your SITRANS Probe LU for optimum performance. We always welcome suggestions and comments about manual content, design, and accessibility. Please direct your comments to [techpubs.smpi@siemens.com](mailto:techpubs.smpi@siemens.com).

For other Siemens level measurement manuals, go to: [www.siemens.com/level](http://www.siemens.com/level) and look under **Level Measurement**.

<sup>1</sup> This warning symbol is used when there is no corresponding caution symbol on the product.

# Application Examples

The application examples used in this manual illustrate typical installations using SITRANS Probe LU. Because there is often a range of ways to approach an application, other configurations may also apply.

In all examples, substitute your own application details. If the examples do not apply to your application, check the applicable parameter reference for the available options.

If you require more information, please contact your Siemens representative. For a complete list of Siemens representatives, please go to:  
[www.siemens.com/processautomation](http://www.siemens.com/processautomation).

## Abbreviations and Identifications

Short form	Long Form	Description	Units
CE / FM / CSA	Conformité Européenne / Factory Mutual / Canadian Standards Association	safety approval	
$C_i$	Internal capacitance		
D/A	Digital to analog		
ETFE	Ethylene-tetrafluoroethylene		
HART	Highway Addressable Remote Transducer		
$I_i$	Input current		mA
$I_o$	Output current		mA
IS	Intrinsically Safe	safety approval	
$L_i$	Internal inductance		mH
LRV	<b>Lower Range Value</b>	value for process empty level	4 mA <sup>1</sup>
LSL	<b>Lower Sensor Limit</b>	below which no PV is anticipated	
$\mu$ s	microsecond	10 <sup>-6</sup>	Second
PBT	Polybutylene Terephthalate		
PED	Pressure Equipment Directive	safety approval	
PVDF	Polyvinylidene fluoride		



Short form	Long Form	Description	Units
ppm	parts per million		
PV	<b>Primary Variable</b>	measured value	
SELV	Safety extra low voltage		
SV	<b>Secondary Variable</b>	equivalent value	
TVT	<b>Time Varying Threshold</b>	sensitivity threshold	
$U_i$	Input voltage		V
$U_o$	Output voltage		V
URV	<b>Upper Range Value</b>	value for process full level	20 mA <sup>1</sup>
USL	<b>Upper Sensor Limit</b>	above which no PV is anticipated	

1. 100% is most commonly set to 20 mA, and 0% to 4 mA: however, the settings can be reversed.

# SITRANS Probe LU (Ultrasonic)

SITRANS Probe LU is a 2-wire loop-powered ultrasonic transmitter for level, volume, and flow monitoring of liquids in storage vessels and simple process vessels, as well as in open channels.

The transducer is available as ETFE (ethylene-tetrafluoroethylene) or PVDF (polyvinylidene fluoride) to suit the chemical conditions of your application. For applications with varying material and process temperatures, the Probe LU incorporates an internal temperature sensor to compensate for temperature changes.

SITRANS Probe LU uses field-proven Sonic Intelligence<sup>®</sup> signal processing.

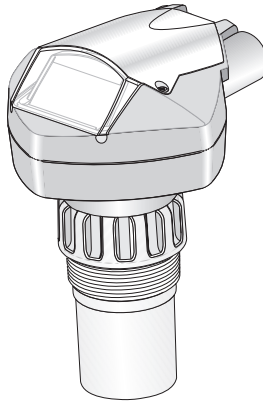

## Applications

### Level, volume or flow

SITRANS Probe LU is designed to measure levels of liquids in a variety of applications:

- storage type vessels
- simple process vessels with some surface agitation
- liquids
- slurries
- open channels

### Volume

By using the volume parameters (P050 to P055) you can obtain the measurement as volume instead of level.

### Flow

If you have an open channel system (a Parshall flume, v-notch weir or other open channel device), you can obtain flow values instead of level. By using the universal linear function of parameter P051, and entering values for Head and Flow in the breakpoint parameters P054 and P055, you can use SITRANS Probe LU to convert head levels into flow rates.

# SITRANS Probe LU System Implementation

SITRANS Probe LU supports the HART communications protocol and SIMATIC® PDM software.

## Typical PLC/mA configuration with HART

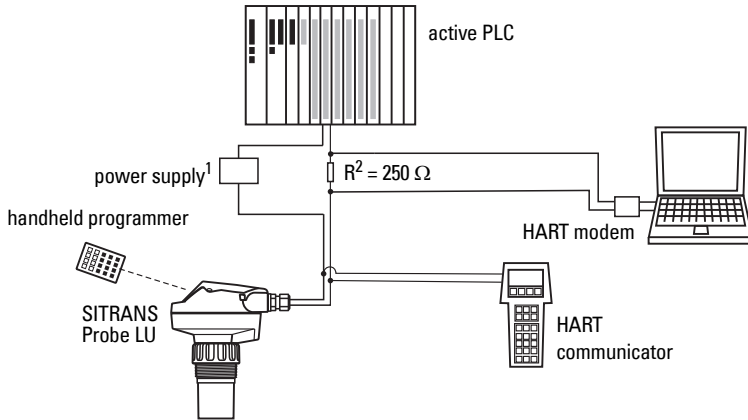

## Programming

SITRANS Probe LU carries out its level measurement function according to the set of built-in parameters. Parameter changes can be made via the handheld programmer, via a PC using SIMATIC PDM, or via a HART Handheld Communicator.

## SITRANS Probe LU Approvals and Certificates

**Note:** Please see *Approvals* on page 9 for an approvals listing.

1. Depending on the system design, the power supply may be separate from the PLC, or integral to it.
2. A 250 Ohm resistor may be required if the loop resistance is less than 250 Ohms.

# Specifications

**Note:** Siemens makes every attempt to ensure the accuracy of these specifications but reserves the right to change them at any time.

## SITRANS Probe LU

### Power

! Nominal 24 V DC at  
max. 550 Ohm.

For other configurations, see the chart *Loop Voltage versus Loop Resistance* on page 91.

- Maximum 30 V DC
- 4 to 20 mA
- Max startup current see *Startup Behavior* on page 88

### Performance<sup>1</sup>

Reference operating conditions according to IEC 60770-1

- ambient temperature +15 to +25 °C
- humidity 45 to 75% relative humidity
- ambient pressure 860 to 1060 mbar

Measurement Accuracy (measured in accordance with IEC 60770-1)

- non-linearity (accuracy) greater of 6 mm (.24") or 0.15% of span (including hysteresis and non-repeatability)
- non-repeatability 3 mm (0.19") [included in non-linearity specification]
- deadband (resolution) 3 mm (0.19") [included in non-linearity specification]
- hysteresis error 0 mm

Analog Output Accuracy (measured in accordance with IEC 60770-1)

- non-linearity (accuracy) 0.125% of span (including hysteresis and repeatability)
- non-repeatability 0.025% of span (included in non-linearity specification)
- deadband (resolution) 0.0375% of span [included in non-linearity specification]
- hysteresis error 0%

Frequency 54 KHz

Measurement range<sup>2</sup>  
6 m (20 ft) model: 0.25 m to 6 m (10" to 20 ft) liquid  
12 m (40 ft) model: 0.25 m to 12 m (10" to 40 ft) liquid

<sup>1</sup> Reference conditions.

<sup>2</sup> Reference point for measurement is the transducer face.

Blanking distance <sup>2</sup>	0.25 m (0.82 ft)
Update time at 4mA	≤ 5 s
Beam angle	10° at –3 dB boundary
Temperature compensation	built in to compensate over temperature range
Memory	non-volatile EEPROM, no battery required

## Interface

- HART standard, integral to analog output
- configuration Siemens SIMATIC PDM (PC), or HART handheld communicator, or Siemens infrared handheld programmer
- analog output 4–20 mA ± 0.02 mA accuracy
- display (local) multi-segment alphanumeric liquid crystal with Bar graph (representing level)

## Programmer (infrared keypad)

Siemens Infrared IS (Intrinsically Safe) Handheld Programmer: for all locations, including hazardous.

- approval ATEX II 1GD, Ex ia IIC T4 Ga, Ex iaD 20 T135 °C, SIRA 01ATEX2147  
IECEx SIR 09.0073 Ex ia IIC T4 Ga, Ex iaD 20 T135 °C  
FM/CSA Class I, Div. 1, Groups A, B, C, D  
INMETRO DNV 12.0075  
Ex ia IIC T4 Ga  
Ex ia IIIC T135 °C Da  
DNV #OCP 0017  
ABNT NBR IEC 60079-0:2008  
ABNT NBR IEC 60079-11:2009  
ABNT NBR IEC 60079-26:2008 e IEC 61241-11:2005
- ambient temperature –20 to +50 °C (–5 to +122 °F)
- interface proprietary infrared pulse signal
- power 3V lithium battery (non-replaceable)
- weight 150 g (0.3 lb)
- color black

## Mechanical

### Process Connections

- threaded connection 2" NPT, BSP, or G (EN ISO 228-1) / PF2 (JIS B 0202)
- flange connections 3" (80 mm) universal flange
- other connections FMS 200 mounting bracket, or customer-supplied mount

### Transducer (2 options)

- ETFE (ethylene-tetrafluoroethylene), or
- PVDF (polyvinylidene fluoride)

## Enclosure

- body construction PBT (polybutylene terephthalate)
- lid construction hard-coated PEI (polyether imide)
- cable inlet 2 x M20x1.5 conduit gland, or 2 x 1/2" NPT thread
- ingress protection Type 4X / NEMA 4X, Type 6 / NEMA 6, IP67, IP68 (see note below)

### Notes:

- Please check the ambient and operating temperatures under *Environmental* on page 8, and *Process* on page 8; also check *Approvals (verify against device nameplate)* on page 9, for the specific configuration you are about to use or install.
- Approved dust-tight and water-tight conduit seals are required for outdoor Type 4X / NEMA 4X, Type 6 / NEMA 6, IP67, IP68 locations.

## Weight

Standard model 2.1 kg (4.6 lb.)

## Environmental

- location indoor/outdoor
- altitude 5000 m (16,404 ft) max.
- ambient temperature -40 to +80 °C (-40 to +176 °F)
- relative humidity suitable for outdoor  
(Type 4X / NEMA 4X, Type 6 / NEMA 6, IP67, IP68 enclosure)
- installation category I
- pollution degree 4
- pressure rating 0.5 bar g/7.25 psi g

## Process

- temperature (at flange or threads) -40 to +85 °C (-40 to +185 °F)
- pressure (vessel) 0.5 bar g/7.25 psi g

## Approvals (verify against device nameplate)

- General CSA<sub>US/C</sub>, FM, CE, C-TICK
- Hazardous Intrinsically Safe: (Europe) ATEX II 1 G Ex ia IIC T4 Ga  
(US/Canada) FM/CSA: (barrier required)<sup>1</sup>  
Class I, Div. 1, Groups A, B, C, D  
Class II, Div. 1, Groups E, F, G  
Class III T4  
(International) IECEx SIR 13.0008X Ex ia IIC T4 Ga  
(Brazil) INMETRO DNV 12.0070X  
Ex ia IIC T4 Ga  
IP67/IP68  
-40 °C ≤ Ta ≤ +80 °C  
DNV #OCP 0017  
ABNT NBR IEC 60079-0:2008  
ABNT NBR IEC 60079-11:2009 e  
ABNT NBR IEC 60079-26:2008  
Non-incendive (US) FM<sup>2</sup>:  
Class I, Div. 2, Groups A,B, C, D T5
- Marine Lloyd's Register of Shipping  
ABS Type Approval

**Note:** Approved dust-tight and water-tight conduit seals are required for outdoor Type 4X / NEMA 4X, Type 6 / NEMA 6, IP67, IP68 locations.

<sup>1</sup> See *FM Intrinsically safe connection drawing* on page 95 or *CSA Intrinsically Safe connection drawing* on page 96.

<sup>2</sup> See *FM Class 1, Div. 2 connection drawing* on page 97.

# Notes

---



# Installation



## WARNINGS:

- **SITRANS Probe LU is to be used only in the manner outlined in this manual, otherwise protection provided by the equipment may be impaired.**
- **Installation shall only be performed by qualified personnel and in accordance with local governing regulations.**

## Notes:

- Refer to the device nameplate for information on approvals.
- This product is susceptible to electrostatic shock. Follow proper grounding procedures.
- Ideally, mount SITRANS Probe LU so that the face of the transducer is at least 300 mm (1 ft) above the highest anticipated level.

## Mounting Location

### Recommendations:

- Ambient temperature within  $-40$  to  $80$  °C ( $-40$  to  $176$  °F).
- Easy access for viewing the display and programming via the handheld programmer.
- An environment suitable to the housing rating and materials of construction.
- Keep the sound path perpendicular to the material surface.

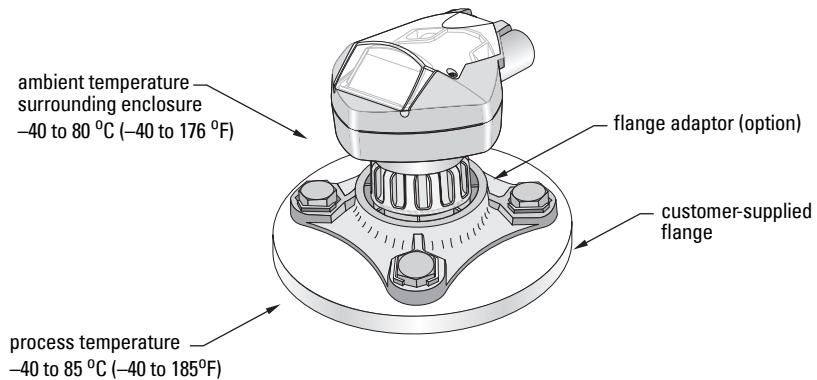

## Precautions:

- Avoid proximity to high voltage or current wiring, high voltage or current contacts, and to variable frequency motor speed controllers.
- Avoid interference to the sound path from obstructions or from the fill path

The sound path should be:

- perpendicular to the monitored surface
- clear of rough walls, seams, rungs, or other obstructions.
- clear of the fill path

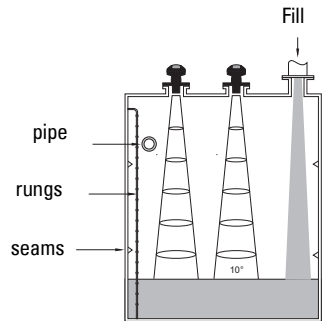
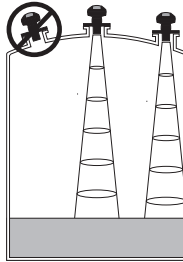

## Mounting Instructions

### Note:

- Ideally, mount SITRANS Probe LU so that the face of the transducer is at least 300 mm (1 ft) above the highest anticipated level.

SITRANS Probe LU is available in three thread types: 2" NPT, 2" BSP, or PF2/G.

1. Before inserting SITRANS Probe LU into its mounting connection, ensure that the threads are of the same type to avoid damaging them.
2. Simply screw SITRANS Probe LU into the process connection and hand tighten or using a strap wrench to seat gasket if required (1/4 turn past hand tight is recommended).

# SITRANS Probe LU Dimensions

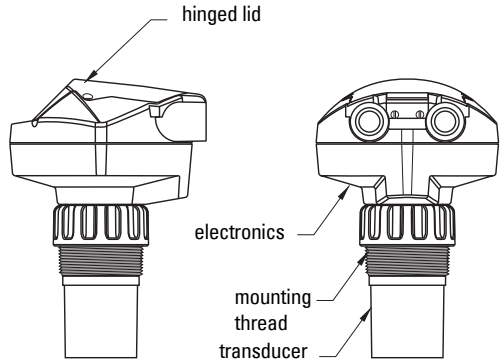
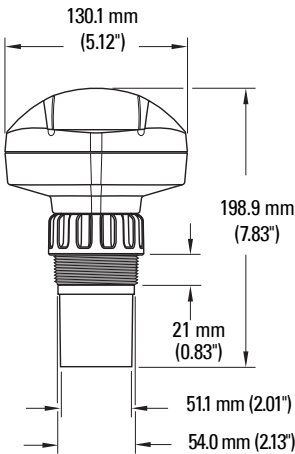
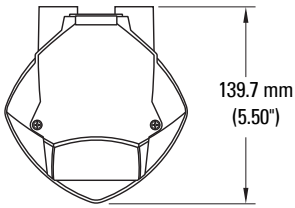

## Flange Adaptor (optional)

SITRANS Probe LU can be fitted with the optional 3" (80 mm) flange adaptor for mating to 3" ANSI, DIN 65PN10 and JIS 10K3B flanges.

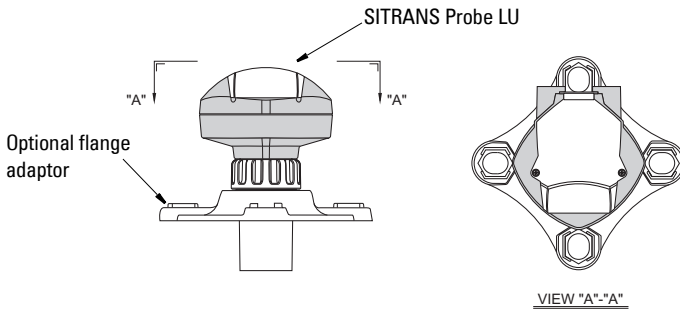

# Wiring

## Power

### WARNINGS:



DC terminals shall be supplied from an SELV<sup>1</sup> source in accordance with IEC-1010-1 Annex H.



All field wiring must have insulation suitable for rated voltages.

## Connecting the SITRANS Probe LU

### Notes:

- Use shielded, twisted pair cable (wire gauge AWG 22 to AWG 14/ 0.34 mm<sup>2</sup> to 2.08 mm<sup>2</sup>).
- Separate cables and conduits may be required to conform to standard instrumentation wiring practices, or electrical codes.
- The non-metallic enclosure does not provide a continuous ground path between conduit connections: use grounding-type bushings and jumpers.
- For Intrinsically Safe setups, see page 89 for detailed information.
- For a Class 1, Div. 2 (FM) configuration, see the connection drawing on page 96.

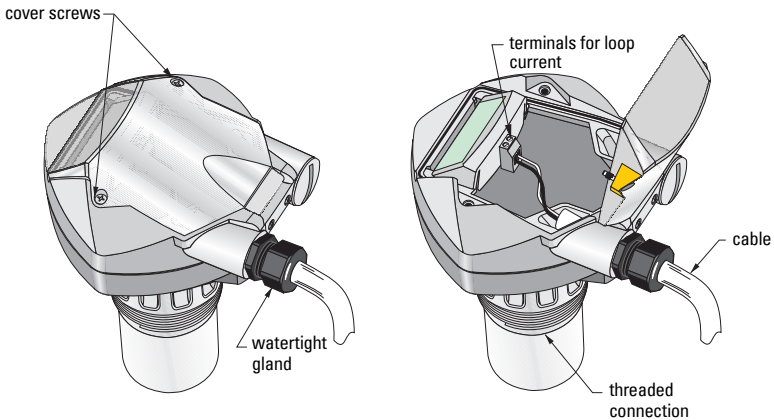

1. Strip the cable jacket for approximately 70 mm (2.75") from the end of the cable, and thread the wires through the gland<sup>2</sup>.

- 
1. Safety Extra Low Voltage
  2. If cable is routed through conduit, use only approved suitable-size hubs for waterproof applications.

2. Connect the wires to the terminals as shown below: the polarity is identified on the terminal block.

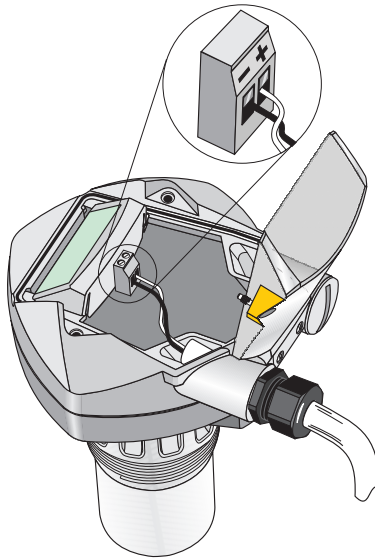

3. Tighten the gland to form a good seal.
4. Close the cover and tighten screws: **please do not overtighten screws.** Recommended torque is 1.1 to 1.7 N-m (10 to 15 in-lb).

# Operating the SITRANS Probe LU

SITRANS Probe LU has two modes of operation: **RUN** and **PROGRAM**.



## RUN Mode

SITRANS Probe LU automatically starts in **RUN** mode when power is applied, and detects the material level. The primary reading displays the material level (in meters) referenced from Empty (process empty level). This is the default start-up display mode.

System status is displayed on the LCD, or on a remote communications terminal.

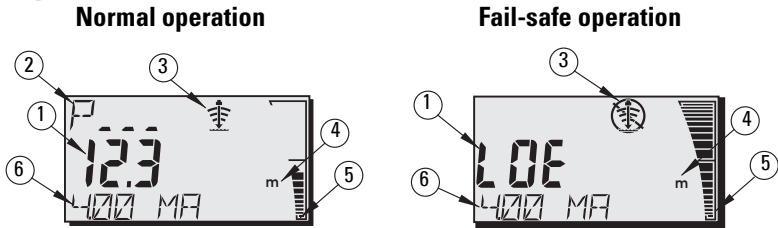
## Display



- 1 – Primary Reading (displays level, distance, or volume (or flow<sup>1</sup>), in either units or percent)
- 2 – Secondary Reading (displays Parameter number for Auxiliary Reading<sup>2</sup>)
- 3 – Echo status indicator: Reliable Echo  or Unreliable Echo 
- 4 – Units or Percent
- 5 – Active bar graph represents material level
- 6 – Auxiliary Reading (depending on the parameter selected, it displays milliAmp value, distance or confidence, with units where applicable)

If the echo confidence drops below the echo confidence threshold<sup>3</sup>, the failsafe timer starts running. When the timer expires, the letters **LOE** alternate with the reading every two seconds, and the Reliable Echo indicator is replaced by the Unreliable Echo indicator. When a valid reading is received, the level reading display returns to normal operation.

1. See *P050 Vessel (or Channel) Shape* on page 35, for details on displaying flow instead of volume.
2. Press  to display the auxiliary reading field when in **RUN** mode.
3. See *P804 Confidence Threshold* on page 57 for more detail.

## Handheld Programmer: function keys in RUN mode

Certain functions can be accessed directly from RUN mode by using specific keys.

Key	Run Mode
	mA output value displayed in auxiliary reading field
	Internal enclosure temperature displayed in auxiliary reading field (P343).
	Parameter for auxiliary readings <sup>1</sup>
	Displays the value representing Echo Confidence (P805).
	Toggle between Units and % on reading display
	Initiate and complete <b>PROGRAM</b> mode access
	Measurement key displays <b>distance</b> in auxiliary reading field.

1. Press plus three-digit parameter number, sets parameter to show in the auxiliary display.

## PROGRAM Mode

### Programming

**Note:** See *Accessing a parameter*, on page 20, for detailed instructions.





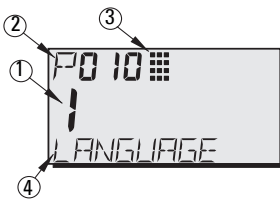





- Set parameters to suit your specific application.
- Activate PROGRAM mode at any time, to change parameter values and set operating conditions.
- For local programming, use the Siemens handheld programmer.
- For programming from a distance, use either a PC running SIMATIC PDM, or a HART handheld communicator.

### Display



- 1 – Primary Reading (displays parameter value)
- 2 – Secondary Reading (displays parameter number)
- 3 – Programming indicator
- 4 – Auxiliary Reading (displays parameter names for parameters P001 to P010, if a language is selected. It displays the index value for indexed parameters, such as P054.)

## Handheld Programmer: function keys in PROGRAM mode

Key	Programming Mode
	Values
	Decimal point
	Negative value
	<b>CLEAR</b> value
	<b>TOGGLE</b> between Units and % on parameter value
	End <b>PROGRAM</b> session and enable <b>RUN</b> mode
	Update echo quality parameters
	Parameter scroll-up
	Parameter scroll-down
	<b>DISPLAY</b> opens parameter fields
	<b>ENTER</b> the displayed value

## Low temperature effects on RUN/PROGRAM modes

If the internal temperature falls to  $-30^{\circ}\text{C}$  ( $-22^{\circ}\text{F}$ ) or below, it will affect both RUN and PROGRAM modes.

**RUN** mode will operate normally, with the following exceptions:

- handheld programmer operation is disabled
- the LCD displays only limited information: the bar graph and the reliable/unreliable echo indicator

**PROGRAM** mode:

- handheld programmer operation is disabled



## Security

The Lock parameter, P000, secures SITRANS Probe LU against changes via the handheld programmer. To enable programming, set P000 to the Unlocked Value stored in P069. To disable programming, enter a different value.

### Note:

- A remote master can still change configuration, if P799 is set to allow this.

## Starting PROGRAM mode

The handheld programmer gives you direct access to SITRANS Probe LU.

## Handheld programmer

**Note:** For detailed instructions on using the handheld programmer, see the next page.

For direct access to SITRANS Probe LU, point the handheld programmer at the display from a maximum distance of 600 mm (2 ft), and press the keys.

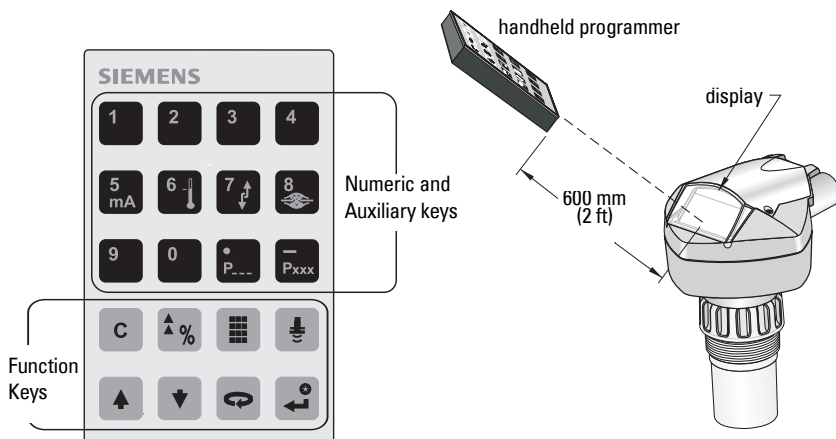

## Activating SITRANS Probe LU







**Note:** Keep infrared devices such as laptops, cell phones, and PDAs, away from SITRANS Probe LU to prevent inadvertent operation.



Power up the instrument. SITRANS Probe LU starts in **RUN** mode, and detects the material level, displayed in meters, referenced from Empty (process empty level).

## Accessing a parameter

### Note:

- The following instructions apply when using the Handheld Programmer.
- Do not use the Handheld Programmer at the same time as SIMATIC PDM, or erratic operation may result.
- You do not need to key in initial zeros when entering a parameter number: for example, for P005, key in **5**.

1. Press **PROGRAM**  then **DISPLAY**  to activate **PROGRAM** mode.
2. Either use the **ARROW** keys   to scroll to a different parameter, or
3. Press **DISPLAY**  to open the Parameter Number field.
4. Key in the desired parameter number followed by **ENTER** .

**For example:** press **5**  .



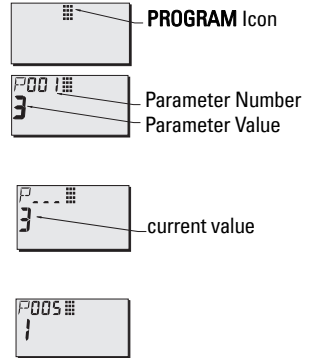

The LCD displays the new parameter number and value.





## Changing a Parameter Value

### Notes:

- Security must be disabled to enable programming: set P000 to the Unlocked Value stored in P069. (For more details, see *P069 Unlocked value* on page 42.)
- Invalid entries will be rejected or limited.
- **CLEAR**  can be used to clear the field

1. Use the **ARROW** keys   to scroll to the parameter number, or press **DISPLAY**  and key in the parameter number followed by **ENTER** .
2. Key in the new value.
3. Press **ENTER**  to set the value.

### Parameter Reset to Factory Default

1. Scroll to the parameter or enter its address.
2. Press **CLEAR**  then **ENTER** . The value returns to the default setting.



## Master Reset (P999)

**Note:** Following a Master Reset, complete programming is required.

Resets all parameters to their factory settings, with the following exceptions:

- P000 and P069 are not reset.
- The learned TVT curve is not lost.

1. Press **PROGRAM**  then **DISPLAY**  to activate **PROGRAM** mode.
2. Press **DISPLAY**  to open parameter fields.
3. Key in **999**.

Press **CLEAR**  then **ENTER** , to Clear All and initiate reset. The LCD displays **C.ALL**



4. Reset complete. (Reset takes several seconds to complete.)



## Using Units or Percent (%)

Many parameters can be viewed either as a percentage, or in measurement units (P005).

View the parameter, then press **MODE**  to toggle between units and percentage.

## Setup Steps (outline)



Set the Quick Start parameters between P001 and P010 (the main settings that apply to all applications and make the system operational). Then set P837 and 838 to ignore false echoes, and return to **RUN** mode.

1. Select a language option<sup>1</sup>, or numeric, for the auxiliary reading (P010).
2. Select the measurement mode: level, space, or distance (P001).
3. Set the response time to level changes (P003).
4. Select units of measurement: m, cm, mm, ft, or in. (P005).
5. Set process empty level (Empty: P006).
6. Set the range to be measured (Span: P007).
7. To ignore false echoes before the material echo, set Auto False-Echo Suppression Distance P838.
8. Enable Auto False-Echo Suppression P837.
9. Return to **RUN** mode.

<sup>1</sup> The language options are English, German, French, or Spanish. The parameter title appears in the language selected, for the first 10 parameters.

# Setup Instructions

## Notes:

- The following instructions apply when using the Handheld Programmer.
- In **PROGRAM** mode, you can use the **ARROW** keys   to scroll to a parameter number.
- The default parameter values are indicated by an asterisk (\*) in the tables.

Using the handheld programmer, set each parameter value to suit your application. (For detailed instructions on accessing a parameter and changing the value, see page 20.)

## 1. Select a language (P010: Language)

If a language is selected, parameter titles for parameters P010 to P001 are displayed in the auxiliary reading field.

Values	0	*	Numeric/None
	1		English
	2		German
	3		French
	4		Spanish

Parameter	Auxiliary reading
P000	LOCK
P001	OPERATION
P002	MATERIAL
P003	MEAS RESP
P005	UNITS
P006	EMPTY
P007	SPAN
P010	LANGUAGE

## 2. Select the measurement mode required for the application (P001: Operation)

Values	1	*	<b>Level</b> returns material level referenced from Empty (process empty level). The reading is returned in volumetric units if parameters 050 to 055 are set to enable this.
	2		<b>Space</b> returns material level referenced from Span (process full level).
	3		<b>Distance</b> returns material level referenced from the transducer face.

To measure how full the vessel is, select **Level**: the reading can be returned as level or as volume (or flow – see P050 on page 35 for details):

- for a level reading, ensure P050 is set to **0**: the reading returns the distance from process empty level (Empty) to the current level
- for a volume reading, select a vessel shape at P050, and set volume parameters 051 to 055 as required

To measure how much space remains in the vessel, select **Space**:

- **Space** returns a reading for the distance between current level and process full level (Span)

To measure the distance from the transducer face to the current level, select **Distance**.

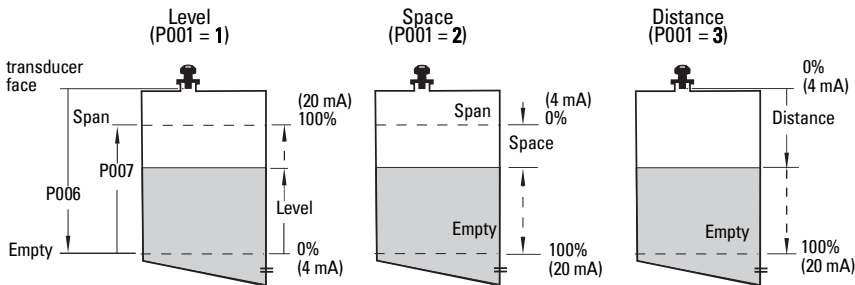

**Notes:**

- Setting P001 resets Span (P007), unless Span has previously been set to a different value. Span is set to Empty distance minus 110% of Blanking<sup>1</sup>, unless Operation is set to distance measurement (P001 = 3). In this case, Span is set to the same value as Empty (P006).
- Changing P001 may reset Output Function (P201): this applies to HART only.

**3. Set response time to maximum filling/emptying rate (P003: Measurement Response)**

Set P003 to a measurement response speed just faster than the maximum filling or emptying rate (whichever is greater).

<b>Values</b>	<b>1</b>	*	slow	0.100 m/minute
	<b>2</b>		medium	1.000 m/minute
	<b>3</b>		fast	10.000 m/minute

Slower settings provide higher accuracy; faster settings allow for more level fluctuation.

(For more detail on measurement response, see *P003 Measurement Response*, on page 32.)

**4. Select type of measurement units required (P005: Units)**

<b>Values</b>	<b>1</b>	*	meters
	<b>2</b>		centimeters
	<b>3</b>		millimeters
	<b>4</b>		feet
	<b>5</b>		inches

<sup>1</sup> Blanking distance is 0.25 m (10"). See *Blanking Distance* on page 85 for more details.

## 5. Set process empty level (P006: Empty)

<b>Values</b>	Range (depends on mode)	0.0000 to 6.00 m (20 ft) or 0.0000 to 12 m (40 ft)
	Default	maximum range: 6.000 m (20 ft), or 12.000 m (40 ft)

Enter the distance from the transducer face to process empty level (Empty) using units sets in P005. Empty can be set to any distance: not necessarily the bottom of the vessel.

**Note:** P006 and P007 are interlinked: see notes attached to P007.

## 6. Set the range to be measured (P007: Span)

<b>Values</b>	Range (depends on model)	0.0000 to 6.00 m (20 ft) or 0.0000 to 12 m (40 ft)
	Default	5.725 m (18.78 ft), or 11.725 m (38.47 ft)

Enter the distance between Empty (process empty level) and Span (process full level), in the units set in P005. Span can be set at any distance above the empty level.

### Notes:

- Setting P006 resets Span, if it has not previously been set to a different value.
- The default setting for Span is based on Operation (P001) and Empty (P006). Span is set to Empty minus 110% of blanking distance<sup>1</sup>, unless Operation is set to **distance** (P001 = 3). In this case, Span is set to Empty distance.
- Always prevent the monitored surface from approaching within 0.3 m (1 ft) of the transducer face. This provides a 0.05 m (2") safety margin, as the minimum detectable distance is 0.25 m (10").

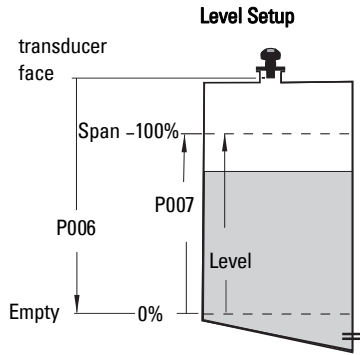

<sup>1</sup> Blanking distance is 0.25 m (10"). See *Blanking Distance* on page 85 for more details.

## 7. Minimize false reflections (P838: Auto False-Echo Suppression Distance)

If SITRANS Probe LU displays an incorrect full level, or if the reading fluctuates between a false high level and a correct level, you can use the TVT (Time Varying Threshold) shaper parameters P838 and P837 together to prevent false-echo<sup>1</sup> detection. P837 and P838 elevate the TVT in this region and de-sensitize the receiver from any 'base noise' caused by internal transducer reflections, nozzle echoes, or other vessel false echoes.

### Notes:

- This function works best when the vessel is empty or nearly empty: use it only if there is a minimum distance of 2 meters from the transducer face to the material.
- Set P837 and P838 during start up, if possible.
- If the vessel contains an agitator, the agitator should be running.

Parameter	Values	
P838	Range (depends on model)	0.0000 to 6.00 m (20 ft) or 0.0000 to 12 m (40 ft)
	Default	1.000 m (3.28 ft)

Use P838 in combination with P837. Determine the actual distance from the transducer face to the material surface. Subtract 0.5 m from this distance and enter the result, following the Setup Instructions for P837.

### Display before Auto False Echo Suppression (or when P837 = 0)

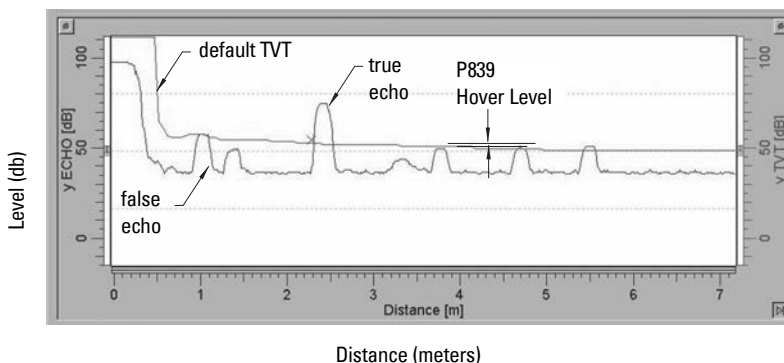





<sup>1</sup> False echoes can be caused by obstructions within the beam path. For more detail, see TVT adjustment parameters, page 60, and TVT curves, page 85.

## 8. Enable False-Echo Suppression (P837: Auto False-Echo Suppression<sup>1</sup>)

Use this feature to ignore false echoes before the material echo. Use P838 to set the Auto TVT distance first.

Parameter	Values	Description
P837	0	* Off
	1	Use "learned" TVT
	2	"Learn"

### Setup Auto False-Echo Suppression:

- Perform this function when the vessel is empty or nearly empty.
- Determine actual distance from transducer face to material level.
- Press **PROGRAM** , then **DISPLAY** .
- Select P838 and key in [distance to material level minus 0.5 m].
- Press **ENTER** .
- Select P837.
- Press **2** and then press **ENTER** . P 837 will automatically revert to **1** (use Learned TVT) after a few seconds.

### Display after Auto False Echo Suppression

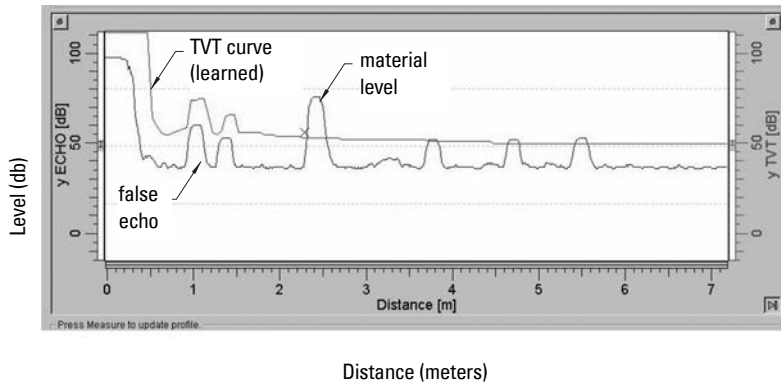

- Press **PROGRAM**  to return to RUN mode.

<sup>1</sup> False echoes can be caused by obstructions within the beam path. For more detail, see TVT adjustment parameters, page 60, and TVT curves, page 85.



# Additional Settings

- Convert readings to volume or flow (P050 to P055)
- Store unlocked value (P069)
- Set Failsafe timer conditions (P070 TO P073)
- Control Analog Output (P201 to P215 and P911)
- Check installation records (P300 to P346)
- Calibrate transducer for unusual conditions (P650 to P654)
- Temperature Compensation (P660 to P664)
- Limit rate of change of reading (P700 and P701)
- Verify measurements (P709 to P713)
- Configure communications (P799)
- Control echo processing (P800 to P825)
- TVT curve adjustments - Auto False Echo Suppression (P830 to P839)
- Software diagnostic tests (P900 and P901)
- Adjust measurements (P911 to P924)





For a full list of available parameters, see *Parameter Reference*, starting on page 29.

# Notes

---

# Parameter Reference

## Notes:

- Keep infrared devices such as laptops, cell phones, and PDAs, away from SITRANS Probe LU to prevent inadvertent operation.
- Do not use the Handheld Programmer at the same time as SIMATIC PDM, or erratic operation may result.
- The following instructions apply when using the Handheld Programmer.
- Press **PROGRAM**  then **DISPLAY**  to access **PROGRAM** mode, and press **PROGRAM**  to return to **RUN** mode.
- **CLEAR**  can be used to clear the field
- Default values (Factory settings) are indicated by an asterisk (\*) in the parameter tables, unless explicitly described.

SITRANS Probe LU is configured through its parameters, and the application determines the parameter values which are entered into the instrument.







Please check your value entries carefully before operating SITRANS Probe LU, to ensure optimum performance.

## Helpful Hints

- **Primary index** is an address: for example, P054.
- **Secondary index** is a sub-address that allows for multiple values on an indexed point, and allows indexed values from more than one parameter to be linked, for example, the breakpoints in P054 and P055. (See pages 37 and 40 for more details.)





## To access a parameter and change a value (primary index):







**Note:** Initial zeros in a parameter number do not have to be entered: for example, for P001, key in 1.

1. Press **PROGRAM**  then **DISPLAY**  to activate **PROGRAM** Mode.
2. Either use the **ARROW** keys   to scroll to each parameter number, or press **DISPLAY**  again to access the parameter number field, and key in the parameter number followed by **ENTER** .
3. Key in the new value.
4. Press **ENTER** .

## To access a secondary index and change a value:

### Notes:

- In a parameter with a secondary index, the **ARROW** keys   control whichever index was most recently changed.
- When you first access a parameter, the **ARROW** keys   control the primary index (parameter number).
- After the secondary index is changed, the **ARROW** keys control the secondary index.
- When the primary index is changed, the **ARROW** keys revert to the primary index.

1. Select the parameter number, for example P054: the secondary index is displayed in the auxiliary reading.
2. Press **DISPLAY**  twice<sup>1</sup> (the auxiliary reading field goes blank).
3. Key in the address of the desired index, or use the **ARROW** keys   to scroll to the desired secondary index number, then press **ENTER** .
4. Key in the new index value and press **ENTER** .
5. Press **DISPLAY**  twice, and use the **ARROW** keys or enter the parameter number to select a different parameter.

## P000 Lock

### Notes:

- This lock only applies to the handheld programmer: it does not lock access through communications.
- A remote master can change configuration if P799 is set to allow this.

*Secures SITRANS Probe LU from parameter changes via the handheld programmer.*

Value	Unlocked Value (P069)	*	Unlocked: programming permitted <sup>1</sup>
	other		

1. The factory setting for P069 is 1954: after a new Unlocked value is entered and accepted, the new value becomes the default setting.

To enable the programming lock:

1. Select P000.
2. Key in any value other than the Unlocked Value (P069).
3. Press **ENTER** to set the value: **PROGRAM** mode is now active for viewing only.

To disable the programming lock:

1. Select P000.
2. Key in the Unlocked Value (P069).
3. Press **ENTER** to set the value: **PROGRAM** mode is now active for programming.

<sup>1</sup> This focusses control on the secondary index.

# Quick Start (P001 to P010)

## P001 Operation

**Note:** Default values are indicated with an asterisk (\*) in the parameter tables, unless explicitly described.

*Sets the type of measurement required for the application. (This affects the local LCD only; the primary variable for HART is controlled by P201.)*

To measure how full the vessel is, select **Level**. The reading can be returned as level or as volume:

- for a level reading, ensure P050 is set to **0**: the reading returns the distance from process empty level (Empty) to the current level
- for a volume reading, select a vessel shape at P050, and set volume parameters 051 to 055 as required

To measure how much space remains in the vessel, select **Space**:

- **Space** returns a reading for the distance between current level and process full level (Span)

To measure the distance from the transducer face to the current level, select **Distance**.

<b>Values</b>	<b>0</b>	Instrument out of service.
	<b>1</b> *	<b>Level</b> returns material level referenced from Empty (process empty level). The reading is returned in volumetric units if parameters 050 to 055 are set to enable this.
	<b>2</b>	<b>Space</b> returns material level referenced from Span (process full level).
	<b>3</b>	<b>Distance</b> returns material level referenced from the transducer face.

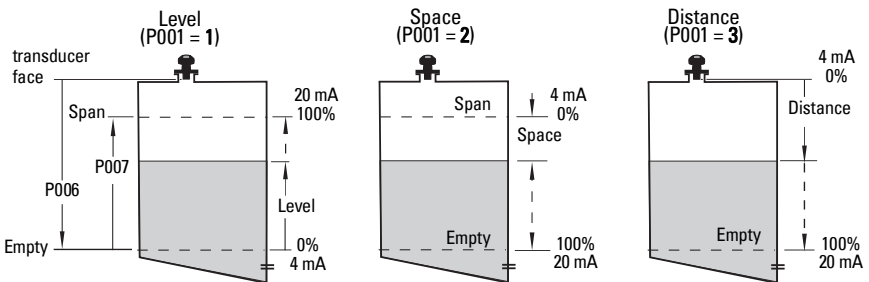

### Notes:

- Setting P001 resets Span (P007), unless Span has previously been set to a different value. Span is set to Empty distance minus 110% of Blanking<sup>1</sup> unless P001 is set to 3 (distance measurement). In this case Span is set to the same value as Empty (P006).
- Changing P001 may reset Output Function (P201).

## P002 Material to be monitored

**Note:** For use only by Siemens service personnel.

## P003 Measurement Response

*Sets the rate of response to level changes.*

Related Parameters	P003		Failsafe Timer P070 (minutes)	Max. Measurement Response P700/P701	Damping Filter P709	Echo Verification P711	
	Values	1	*	slow	100.00	0.100 m/minute	10.000 s
2			medium	10.00	1.000 m/minute	10.000 s	2
3			fast	1.00	10.000 m/minute	1.000 s	2

**Note:** Changing P003 resets the following parameters: P070, P700, P701, P709, and P711.

Use a setting just faster than the maximum filling or emptying rate (whichever is greater). Slower settings provide higher accuracy; faster settings allow for more level fluctuation.

- **Echo Verification (P711):** discriminates between agitator blades in motion (spurious noise) and the target surface (true echo).
- **Failsafe timer (P070):** establishes the period from the time a loss of echo (LOE) starts until the Failsafe default (P071) is triggered. P070 takes precedence over P003.

<sup>1</sup> Blanking distance is 0.25 m (10"). See *Blanking Distance* on page 85 for more details.

## P005 Units

*Specifies measurement units used for dimensional values.*

<b>Values</b>	<b>1</b>	*	meters
	<b>2</b>		centimeters
	<b>3</b>		millimeters
	<b>4</b>		feet
	<b>5</b>		inches

## P006 Empty (process empty level)

*Sets the distance from the transducer face to the process empty level, in units selected at P005.*

<b>Values</b>	Range (depends on model)	0.0000 to 6.10 m (20.01 ft) or 0.0000 to 12.20 m (40.02 ft)
	Default	Max. range: 6.10 m (20.01 ft) or 12.20 m (40.02 ft)

Enter the distance from the transducer face to Empty (process empty level), using units set in P005. Empty can be set to any distance: not necessarily the bottom of the vessel

### Notes:

- Default setting is maximum range.
- P006 and P007 are interlinked: see note attached to P007.

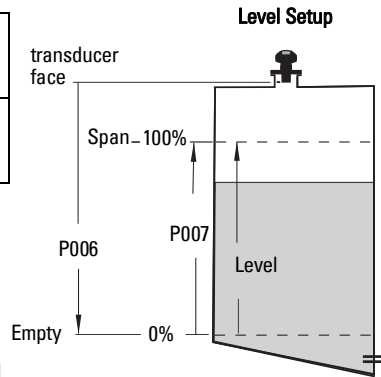

## P007 Span (process full level)

*Sets the range to be measured (referenced from Empty) in units selected at P005.*

<b>Values</b>	Range (depends on model)	0.0000 to 6.00 m (20 ft) or 0.0000 to 12 m (40 ft)
	Default	5.725 m (18.78 ft) or 11.725 m (38.47 ft) See note on next page for more details.

Enter the distance between Empty (process empty level) and Span (process full level), in units set in P005. Span can be set at any distance above Empty level.

### Notes:

- Setting P006 will reset Span, if it has not previously been set to a different value.
- The default setting for Span is based on Operation (P001) and Empty (P006). Span is set to Empty minus 110% of Blanking<sup>1</sup> distance, unless Operation is set to **Distance** (P001 = 3). In this case, Span is set to Empty distance.
- Always prevent the monitored surface from approaching within 0.3 m (1 ft) of the transducer face. This provides a 0.05 m (2") safety margin, as the minimum detectable distance is 0.25 m (10").

## P010 Language

*Selects the language used for the auxiliary reading on the display.*

<b>Values</b>	<b>0</b>	<b>*</b>	Numeric / None
	<b>1</b>		English
	<b>2</b>		German
	<b>3</b>		French
	<b>4</b>		Spanish

If a language is selected, parameter titles for the Quick Start parameters are displayed. (See the table on page 22 for the titles displayed.)

## Volume (or Flow) P050 to P055

*Set SITRANS Probe LU to calculate readings based on reservoir volume instead of level: see P050 Vessel (or Channel) Shape on page 35 for details on displaying flowrate.*

1. Operation must be set to Level (P001 = 1).
2. Select a vessel shape matching the monitored vessel (P050).
3. If required, add dimensions A or L (as shown in the chart on page 36), using P052 and P053,  
or, if vessel shape 9 is selected, add level and volume breakpoints in P054 and P055.
4. Enter the value for the maximum vessel volume in P051.
5. Return to **RUN** mode: readings are now displayed in volumetric units. To select **PERCENT**, press  $\left[ \frac{1}{2} \% \right]$ : the displayed volume reading will be a percentage of Maximum Volume.

---

<sup>1</sup> Blanking distance is 0.25 m (10").



## P050 Vessel (or Channel) Shape

*Defines the vessel (or open channel) shape (see chart on next page) and allows SITRANS Probe LU to calculate volume or flow instead of level. The default setting for P050 is 0 (volume calculation not required).*

Enter the value for the vessel shape matching the monitored vessel or reservoir (see chart on page 36).

## P051 Maximum Volume

*For readings in volumetric units instead of percentage values, enter the vessel volume corresponding to Span (P007). Any volumetric units can be chosen, because the volume calculation is based on the maximum volume, and scaled according to the Vessel Shape (P050) value. If no value is entered, the default is 100, and the reading will be a percentage value.*

<b>Values</b>	Range	0.0000 to 99999
	Default	100.0
<b>Related Parameters</b>	P006 Empty P007 Span	





Enter the vessel volume corresponding to Span (P007).

1. Key in the value. (For example, if maximum volume = 3650 m<sup>3</sup>, key in 3650.)
2. Press **ENTER** .

If the value is too large for the LCD display, enter larger units.

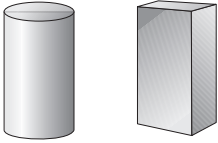
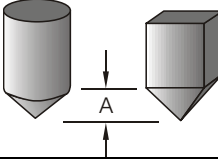
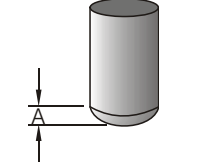
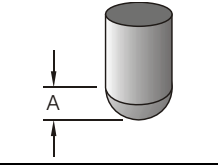
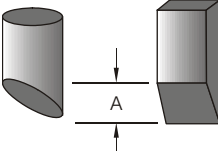
**Example:**

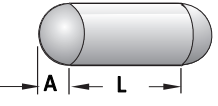
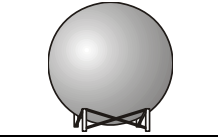
If maximum volume = 267,500 gallons, key in **267.5** (thousands of gallons.).

P050 Value	Vessel Shape	Description	Also required	
0	*	----	no volume calculation required	N/A
1		flat bottom	P051	
2		conical or pyramidal bottom	P051, P052	
3		parabolic bottom	P051, P052	
4		spherical bottom	P051, P052	
5		angled bottom	P051, P052	
6		flat end cylinder	P051	
7		parabolic end cylinder	P051, P052, P053	
8		sphere	P051	
9		universal linear level/volume/flow breakpoints	P051, P054, P055	

## P052 Vessel Dimension A

*Dimension A as used for P050 Vessel Shapes 2, 3, 4, 5, or 7, in the chart on page 36.*

<b>Values</b>	Range	<b>0.0000 to 99999</b> in units (P005)
	Default	0.0
	----	Display when P050 = <b>0</b>
<b>Related Parameters</b>	P050 Vessel Shape	

Enter one of the following, using the units selected in P005:

- height of the vessel bottom if P050 = **2, 3, 4, or 5**
- length of one end-section of the vessel if P050 = **7**

## P053 Vessel Dimension L

*Dimension L as used in P050 Vessel Shape 7, in the chart on page 36.*

<b>Values</b>	Range	<b>0.0000 to 99999</b> in units (P005)
	Default	0.0
	----	Display when P050 = <b>0</b>
<b>Related Parameters</b>	P050 Vessel Shape	

Enter the vessel length **L** (excluding both end sections) if P050 = **7**. Use the units selected in P005.

## P054 Level or Head Breakpoints







*P054 and 055 can be used to calculate either level and volume in a vessel, or head level and flow rate in an open channel device. (For more information on Open Channel Monitoring, please see Open Channel Monitoring (OCM) on page 87).*

### Level Breakpoints

*When the vessel shape is too complex for any of the preconfigured shapes, you can define the shape as a series of segments. In P054 you assign a level value to each breakpoint. In P055 you assign a corresponding volume value to each breakpoint.*

<b>Primary Index</b>	P054	
<b>Secondary Index</b>	Breakpoint number	
<b>Values</b>	Range	0.0000 to 99999 in units (P005)
	Default	0.000
<b>Related Parameters</b>	P055 Volume or Flow Breakpoints	

Enter up to 32 level breakpoints, where the corresponding volume is known. The 100% and 0% levels must be entered. The breakpoints can be ordered from top to bottom, or the reverse.

1. First set P050 to 9.
2. Select P054.
3. The default breakpoint value appears, with the breakpoint number in the auxiliary reading.
4. Press **DISPLAY**  twice to focus control on the secondary index<sup>1</sup> (the auxiliary reading field goes blank).
5. Key in 1 and press **ENTER** .
6. Key in the level value for breakpoint 1, and press **ENTER** . (Use units defined in P005.)
7. Press the **UP ARROW** key  to display 02 in the auxiliary reading.
8. Key in the level value for breakpoint 2, and press **ENTER** .
9. Repeat steps 7 and 8 until level values have been entered for all the required breakpoints.
10. Press **DISPLAY**  twice and use the **UP ARROW** key  to go to P055.

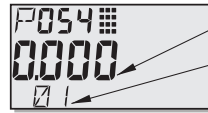

breakpoint value field  
breakpoint number

**Example:**

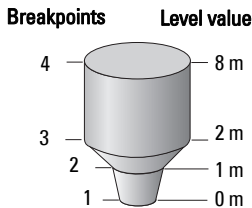

Breakpoint number	Level breakpoint (P054)	Volume breakpoint (P055)
1	0	0
2	1	200
3	2	1200
4	8	3200

**Note:** Illustrated values for P054 and P055 are for example purposes only.









<sup>1</sup> For more details on secondary index operation, see page 30.

## Head Breakpoints

When measuring flow in an open channel device, you can define the cross-section of the channel as a series of segments. In P054 you assign a head value to each breakpoint. In P055 you assign a corresponding flow value to each breakpoint.

<b>Primary Index</b>	P054	
<b>Secondary Index</b>	Breakpoint number	
<b>Values</b>	Range	0.0000 to 99999 in units (P005)
	Default	0.000
<b>Related Parameters</b>	P055 Flow Breakpoints	

Enter up to 32 head breakpoints, where the corresponding flow is known. The 100% and 0% levels must be entered. The breakpoints can be ordered from top to bottom, or the reverse.

1. First set P050 to **9**.
  2. Select P054.
  3. The default breakpoint value appears, with the breakpoint number in the auxiliary reading.
- 
4. Press **DISPLAY**  twice to focus control on the secondary index<sup>1</sup> (the auxiliary reading field goes blank).
  5. Key in 1 and press **ENTER** .
  6. Key in the head value for breakpoint 1, and press **ENTER** . (Use units defined in P005.)
  7. Press the **UP ARROW** key  to display 02 in the auxiliary reading.
  8. Key in the head value for breakpoint 2, and press **ENTER** .
  9. Repeat steps 7 and 8 until head values have been entered for all the required breakpoints.
  10. Press **DISPLAY**  twice and use the **UP ARROW** key  to go to P055.

**Example: v-notch weir:**

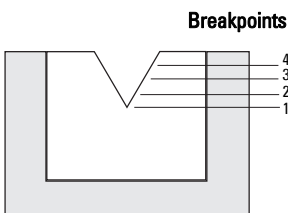

Break -point	Head (P054)	Flow (P055)
4	0.4 m	113.5
3	0.3 m	55.3
2	0.2 m	20.07
1	0 m	0

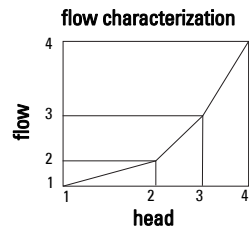

**Note:** Illustrated values for P054 and P055 are for example purposes only.

<sup>1</sup> For more details on secondary index operation, see page 30.

## P055 Volume or Flow Breakpoints

If you are measuring level and volume, follow the Volume Breakpoints instructions below. If you are measuring head and flow, follow the Flow Breakpoints instructions on page 41.

### Volume breakpoints





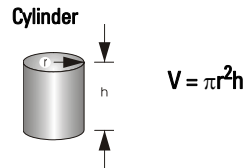
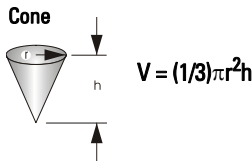

Each segment defined by the level breakpoints (P054) requires a corresponding volume, so that SITRANS Probe LU can make the level-to-volume calculations.

<b>Primary Index</b>	P055	
<b>Secondary Index</b>	Breakpoint number	
<b>Values</b>	Range	0.0000 to 99999 in units
	Default	0.0000
<b>Related Parameters</b>	P054 Level Breakpoints	

### Typical volume calculations:



Enter a volume for each breakpoint defined in P054. (See illustrated example for P054 on the previous page.)

1. P050 must be set to **9**.
2. Select P055.
3. The empty breakpoint value field appears, with the breakpoint number in the auxiliary reading field.
4. Press **DISPLAY**  twice to focus control on the secondary index<sup>1</sup> (the auxiliary reading field goes blank).
5. Key in 1 and press **ENTER** .
6. Key in the volume for breakpoint 1, and press **ENTER** . (Any volumetric units can be used: see note to P051.)
7. Press the **UP ARROW** key  to display 02 in the auxiliary reading.
8. Key in the volume for breakpoint 2, and press **ENTER** .
9. Repeat steps 7 and 8 until volume values have been entered for all the required breakpoints.
10. Press **DISPLAY**  twice and use the **ARROW** keys or enter the value for the next desired parameter.

<sup>1</sup> For more details on secondary index operation, see page 30.







## Flow breakpoints

Each segment defined by the head breakpoints (P054) requires a corresponding flow value, so that SITRANS Probe LU can make the head-to-flow calculations.

<b>Primary Index</b>	P055	
<b>Secondary Index</b>	Breakpoint number	
<b>Values</b>	Range	0.0000 to 99999 in units
	Default	0.0000
<b>Related Parameters</b>	P054 Head Breakpoints	

Use the Flow Tables associated with your open channel device (Parshall flume, v-notch weir, or other measuring device) to calculate the flow rate for each head breakpoint.

Enter a flow value for each breakpoint defined in P054. (See illustrated example for Head Breakpoints on page 39.)

1. P050 must be set to **9**.
2. Select P055.
3. The empty breakpoint value field appears, with the breakpoint number in the auxiliary reading field.
4. Press **DISPLAY**  twice to focus control on the secondary index<sup>1</sup> (the auxiliary reading field goes blank).
5. Key in 1 and press **ENTER** .
6. Key in the flow value for breakpoint 1, and press **ENTER** .
7. Press the **UP ARROW** key  to display 02 in the auxiliary reading.
8. Key in the flow value for breakpoint 2, and press **ENTER** .
9. Repeat steps 7 and 8 until flow values have been entered for all the required breakpoints.
10. Press **DISPLAY**  twice and use the **ARROW** keys or enter the value for the next desired parameter.

<sup>1</sup> For more details on secondary index operation, see page 30.

# Lock (P069)

## P069 Unlocked value

Stores the value to enter in Lock (P000) to unlock programming. If P000 is locked, P069 will not display the Unlocked value.

<b>Values</b>	Range	<b>1 to 9999</b>
	Default	<b>1954</b>
	----	Display when P000 is locked

### Notes:

- Default setting for P000 is unlocked.
- After a new value has been stored at P069, that value will be recalled after a master reset (P999).
- Consult your Siemens representative, if you have forgotten the unlocked value.

## Failsafe (P070 to P073)

### P070 Failsafe Timer

Sets the time to elapse in minutes since the last valid reading, before Failsafe State activates.

<b>Values</b>	Range	0.0000 to 720.00 min.
	Default	100.00 (based on P003)

**Note:** The last valid reading is maintained until the Failsafe timer expires. After the timer expires, the reading is set based on P071.

### P071 Failsafe Material Level

Allows you to select the material level to be reported when the Failsafe Timer expires. (For more detail, see Failsafe on page 87.)

<b>Values</b>	<b>1</b>	Use Maximum mA Limit (P213) as material level
	<b>2</b>	Use Minimum mA Limit (P212) as material level
	<b>3</b>	* Level remains at last reading
	<b>4</b>	User-selected value (defined in P073)

1. Enter the value corresponding to the level you want reported when the Failsafe Timer expires.
2. Press **ENTER** .



## P073 Failsafe level

*Defines a user-defined level to report when the Failsafe timer expires.*

<b>Values</b>	Range	3.6000 mA to 22.600 mA
	Default	22.600 mA

**Note:** P071 must be set to **User-selected value (4)** to use this value.

## mA Output (P201 to P215)

### P201 mA Output Function

*Alters the mA output/measurement relationship, and allows the output to be set independently from P001. If a HART master is connected, only the master can change the value.*

<b>Values</b>	<b>0</b>	manual
	<b>1</b> *	level
	<b>2</b>	space
	<b>3</b>	distance
	<b>4</b>	volume (only available if a tank shape has been selected at P050) or flow (only available if 9 is selected at P050, and head level and flow breakpoints are set at P054 and P055)

#### Notes:

- P201 is set independently from P001: set P001 first, as changing P001 will reset P201 to the same setting.
- P201 controls the primary value and the loop current for the HART common module and should not be changed if using HART.
- Selection also affects the secondary, tertiary, and quaternary variables for HART.
- P201 must be set to **0** (manual) before you can modify P911. Remember to restore the previous setting after using P911.

### Independent mA Setpoint Parameters (P210 and P211)

*P210 and P211 allow you to explicitly define the normal operating range. Use these features to reference the minimum and/or maximum mA output to any point in the measurement range.*

For HART, 4 mA and 20 mA represent the upper and lower range limits for the primary variable.

P201 (mA Function) Settings	Response for P210 and P211
Level, Space, or Distance	Key in the material level in Units (P005) or percent <sup>1</sup> of Span (P007) as referenced from Empty (P006).
Volume	Key in the volume in Maximum Volume (P051) units or as a percent <sup>1</sup> of Maximum Volume.

1. Ensure the % symbol is displayed before entering a % value.

## P210 4 mA Setpoint (low output)

**Note:** P210 is used to set the 4 mA loop current for the HART common module.

*Sets the process level corresponding to the 4 mA value. 4 mA always defaults to 0, and P201 determines whether this is a Level, Space, Distance, or Volume (or flow)<sup>1</sup> measurement. Level and Space are measured as a percentage of Span; Distance is measured as a percentage of Empty.*

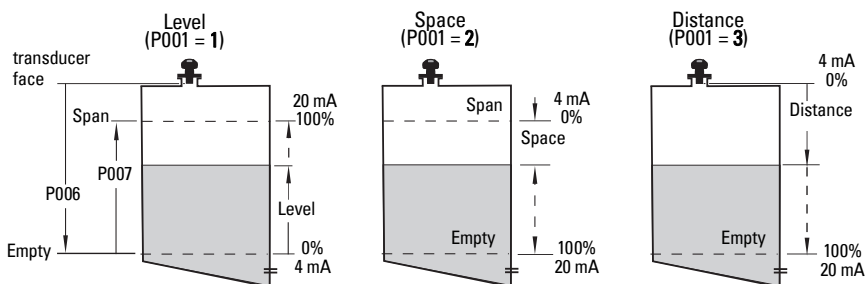

<b>Values</b>	Range	-99999 to 99999.
	Default	0.000 m (set to 0% as defined by P201: mA Output Function)
<b>Related Parameters</b>	P201: mA Output Function	

Enter the reading that is to correspond to a 4 mA output. Use percent or units, depending on the setting for P051.

<sup>1</sup>. To display flowrate instead of volume, see *P050 Vessel (or Channel) Shape* on page 35.

## P211 20 mA Setpoint (high output)

*Sets the process level corresponding to the 20 mA value. 20 mA always defaults to 100%, and P201 determines whether this is a Level, Space, or Distance measurement. Level and Space are measured as a percentage of Span: Distance is measured as a percentage of Empty.*

<b>Values</b>	Range	-99999 to 99999.
	Default (depends on model)	5.725 m (18.78 ft) or 11.725 m (38.47 ft); set to 100% as defined by P201: mA Output Function.
<b>Related Parameters</b>	P201: mA Output Function	

Enter the reading that is to correspond to a 20 mA output, Use percent or units, depending on the setting for P051.

**Note:** P211 is used to set the 20 mA loop current for the HART common module.

## mA Output Limit Parameters (P212 and P213)

*P212 and P213 allow you to explicitly set a failsafe current outside the normal operating range.*

### P212 Minimum mA limit

*Prevents the mA output from dropping below this minimum level for a measurement value. This does not restrict the Failsafe or manual settings.*

<b>Values</b>	Range	3.800 to 20.500 (mA)
	Default	3.800 (mA)

### P213 Maximum mA limit

*Prevents the mA output from rising above this maximum level for a measurement value. This does not restrict the Failsafe or manual settings.*

<b>Values</b>	Range	3.800 to 20.500 (mA)
	Default	20.500 (mA)

## P214 4 mA Output Trim

**Note:** This parameter is for use only by Siemens service personnel.

*Calibrates the 4 mA output.*

## P215 20 mA Output Trim

**Note:** This parameter is for use only by Siemens service personnel.

*Calibrates the 20 mA output.*

## Installation Records (P300 to P346)

### P300 Temperature, transducer maximum

*Shows the highest temperature encountered (in degrees C), as measured by the temperature sensor in the transducer (if applicable).*

<b>Primary Index</b>	Transducer	
<b>Values (view only)</b>	Range	-50 to 150 oC (view only)
	Default	-50 (oC)

Press **CLEAR** [c] then **ENTER** [↵], to reset the log after a short circuit on the transducer wiring.

### P341 RUN Time

*Displays the number of uninterrupted 24 hour periods that the device has been operating.*

<b>Values (view only)</b>	Range	0 to 99999 (days)
	Default:	0
<b>Related</b>	P342: Power-on Resets	

P341 is updated once a day.

- If power is cycled before 24 hours have passed, the run time will not be updated.
- If an instrument is powered down on a regular basis, P341 will not have an accurate value.

## P342 Power-On Resets

*The number of times power has been applied since the date of manufacture.*

<b>Values (view only)</b>	Display	0.0 to 99999
	Default:	0
<b>Related</b>	P341 RUN Time	



This parameter is updated every time the instrument is reset or is powered up.

## P343 Internal Temperature

**! WARNING: Internal temperature must not exceed 80 °C (176 °F).**

*Displays (in degrees C) either the current temperature on the circuit board, or the maximum or minimum temperature recorded by the internal sensor. The high and low values are maintained over a power cycle.*



<b>Primary Index</b>	P343		
<b>Value (view only)</b>	Range	-50 °C to 150 °C	
<b>Secondary Index</b>	1	*	Current temperature
	2		Maximum temperature
	3		Minimum temperature

1. Select P343.
2. The primary reading displays a temperature, and the secondary index number is visible in the auxiliary reading field.
3. Press **DISPLAY**  twice to focus control on the secondary index.
4. Key in the index number required, and press **ENTER** .
5. The temperature value associated with the new secondary index appears.
6. Press **DISPLAY**  twice and use the **ARROW** keys or enter the value for the next desired parameter.

## P346 Serial Number

*Displays the serial number of the instrument. The numbers stored in Index 2, followed by the numbers stored in Index 1, give you the complete serial number.*

	Index 2	Index 1	
<b>Values (view only)</b>	Range: <b>00000 to 99999</b>	Range: <b>00000 to 99999</b>	
Example: <b>1503010</b>	<b>15</b>	<b>03</b>	<b>010</b>

1. Select P346.
2. The primary reading displays one part of the serial number, with the secondary index number visible in the auxiliary reading field.
3. Press **DISPLAY**  twice to focus control on the secondary index.
4. Key in the other index number and press **ENTER** .
5. The other part of the serial number, associated with the new secondary index, appears.
6. Press **DISPLAY**  twice and use the **ARROW** keys or enter the value for the next desired parameter.

## Range Calibration (P650 to P654)

*There are two possible types of calibration:*

- Offset Adjusts the measurement by a fixed amount
- Sound Velocity Adjusts speed of sound, and changes the measurement calculations

Do Offset calibration at any steady level, unless a Sound Velocity calibration is also done. If both calibrations are done, then do Offset at a known high level, and Sound Velocity at a known low level.

## P650 Offset Calibration

*Calibrates Empty (P006) if the reported level is consistently high or low by a fixed amount (stored in P652).*



<b>Values</b>	Range	<b>-99999 to 99999</b>
<b>Related</b>	<ul style="list-style-type: none"><li>• P006 Empty</li><li>• P652 Offset Correction</li><li>• P664 Temperature</li></ul>	

**Before using this feature, verify the following parameters are correct:**

- Empty (P006)
- Temperature (P664)

### Offset Calibration

Begin with a steady level.

1. Press the measurement key [  ] to display the calculated reading.
2. Repeat step 1 at least five times, to verify repeatability.
3. Measure the actual reading (use tape measure).
4. Key in the actual value, and press **ENTER** [  ].

The deviation between the entered Empty (P006) value and the calibrated Empty value is stored in Offset Correction (P652).

## P651 Sound Velocity Calibration

*Calibrates the speed of sound constant.*

<b>Values</b>	Range	<b>-99999 to 999999</b>
<b>Related</b>	<ul style="list-style-type: none"><li>• P653 Velocity</li><li>• P654 Velocity at 20 °C</li></ul>	

Use P651 under the following conditions:

- The acoustic beam atmosphere is other than air.
- The acoustic beam atmosphere temperature is unknown.
- The reading accuracy is acceptable only at higher material levels.

For best results, calibrate with the level at a known value close to empty.

## Using Sound Velocity Calibration

Ensure a steady level at some low value (P653 and P654 adjusted accordingly).

1. Allow sufficient time for the vapor concentration to stabilize.
2. Press the measurement key  to display the calculated reading.
3. Repeat step 2 at least five times to verify repeatability.
4. Measure the actual reading (use tape measure).
5. Enter the actual value.
6. Repeat this procedure if the atmosphere type, concentration, or temperature conditions are different from when the last sound velocity calibration was performed.

**Note:** In gases other than air, the temperature variation may not correspond with the speed of sound variation. Use P660 and P661 to select a temperature source, and use a fixed temperature.

## P652 Offset Correction

*Stores the fixed offset value determined when an Offset Calibration is performed.*

<b>Values</b>	Range	-99999 to 99999
<b>Related</b>	• P650 Offset Calibration	

Alternatively, if the amount of Offset Correction required is known, enter the amount to be added to the Reading before display.

## P653 Velocity

### Notes:

- P653 can only be accessed by entering the parameter number.
- The user cannot change the value of P653 directly, but can affect it via P654 or by P660/P661.

*Displays the value adjusted based on the Sound Velocity at 20°C (P654) versus Temperature (P664) characteristics of air.*

<b>Values (view only)</b>	Range	50.01 to 2001 m/s (164.1 to 6563 ft/s)
<b>Related</b>	• P651 Sound Velocity Calibration • P654 Sound Velocity at 20 °C • P660/P661 Temperature setting	

The units used depend on the setting for P005:

- m/s if P005 = 1, 2, or 3
- ft/s if P005 = 4 or 5.



## P654 Sound Velocity at 20 °C

*This value is used to automatically calculate Sound Velocity (P653).*

<b>Values</b>	Range	50.01 to 2001 m/s (164.1 to 6563 ft/s)
<b>Related</b>	<ul style="list-style-type: none"> <li>• P005 Units</li> <li>• P651 Sound Velocity Calibration</li> <li>• P653 Velocity</li> </ul>	

After performing a sound Velocity Calibration, check this value to verify the acoustic beam atmosphere in air (344.1 m/s or 1129 ft/s).

## Temperature Compensation (P660 to P664)

### P660 Temperature source

*Determines the source of the temperature reading used for calculating speed of sound.*

<b>Values</b>	1	*	Transducer (P664)
	2		Fixed temperature (P661)

**Note:** Maximum Temperature (P300) always uses the transducer as source: it is not affected by P660.

### P661 Temperature fixed

*Defines the fixed temperature (in °C) used for calculating speed of sound if P660 is set to 2 (fixed temperature).*

<b>Values</b>	Range	-40 to 85 °C
	Default	20 (°C)

Use this function when you want to manually override the temperature sensor with a fixed temperature value.

- Set P660 to **2**.
- Enter the fixed temperature value you want to use in place of the sensor temperature.

## P664 Temperature

*Displays the temperature (in °C) read from the transducer.*

<b>Values</b>	Range	-40 to 85 (°C)
---------------	-------	----------------

## Rate (P700 and P701)

*These parameters determine how material level changes are reported.*

### P700 Maximum Fill Rate

*Allows you to further adjust the SITRANS Probe LU response to increases in the actual material level (or an advance to a higher Failsafe Material Level, P071). P700 is automatically updated whenever Measurement Response (P003) is altered.*

<b>Values</b>	Range	0.0000 to 99999 m / min.
	Default	0.100
<b>Altered by</b>	P003 Measurement Response	
<b>Related</b>	P005 Units P007 Span P071 Failsafe Material Level	

Enter a value slightly greater than the maximum vessel-filling rate, in Units (P005) or percent of Span (P007) per minute.

<b>P003 Value</b>	<b>Meters/Minute</b>
1	0.100
2	1.0000
3	10.000

### P701 Maximum Empty Rate

*Adjusts the SITRANS Probe LU response to decreases in the actual material level (or an advance to a lower Failsafe Material Level, P071). P701 is automatically updated whenever Measurement Response (P003) is altered.*

<b>Values</b>	Range	0.0000 to 99999 m / min.
	Default	0.100 (m)
<b>Altered by</b>	P003 Measurement Response	
<b>Related</b>	P005 Units P007 Span P071 Failsafe Material Level	

Enter a value slightly greater than the vessel's maximum emptying rate, in Units (P005) or percent of Span (P007) per minute.

P003 Value	Meters/Minute
1	0.100
2	1.0000
3	10.000

## Measurement Verification (P709 to P713)

### P709 Damping Filter

*Stabilizes the reported level within the Echo Lock Window (P713) in the event of level fluctuations (for example, a rippling or splashing liquid surface). The value is in seconds, and depends on the number of seconds it takes the device to reach 63% of a step value change in reading.*

<b>Values</b>	Range	0 to 100.00 seconds (0 = off)
	Default	10.000 seconds
<b>Altered by</b>	P003 Measurement Response	
<b>Related</b>	P007 Span P713 Echo Lock Window	

The value is automatically altered when Measurement Response Speed (P003) changes. The higher the value entered, the greater the range of stabilized fluctuation.

### P711 Echo Lock

*Use this feature to select the measurement verification process.*

<b>Values</b>	<b>0</b>	Off
	<b>1</b>	Maximum Verification
	<b>2</b>	* Material Agitator
	<b>3</b>	Total Lock
<b>Related</b>	P700 Maximum Fill Rate P701 Maximum Empty Rate P712 Echo Lock Sampling P713 Echo Lock Window P820 Algorithm	

If a material agitator or mixer is used in the monitored vessel, set Echo Lock for Maximum Verification or Material Agitator, to avoid agitator blade detection.

**Note:** Ensure the agitator is always running while SITRANS Probe LU is monitoring the vessel, to avoid stationary blade detection.

- When Maximum Verification or Material Agitator is selected, a new measurement outside the Echo Lock Window (P713) must meet the sampling criterion (P712).
- When Total Lock is selected, Echo Lock Window (P713) is pre-set to **0**.

SITRANS Probe LU continuously searches for the best echo according to the algorithm chosen (P820). If the selected echo is within the window, the window is then centered about the echo. If not, the window widens with each successive shot until the selected echo is within the window. The window then returns to its normal width.

When Echo Lock is Off, SITRANS Probe LU responds immediately to a new measurement, as restricted by the Maximum Fill / Empty Rate (P700 / P701). However, measurement reliability is affected.

## P712 Echo Lock Sampling

*The sampling criterion sets the number of consecutive echoes that must appear above or below the echo currently locked onto, before the measurements are validated as the new reading. (Echo Lock P711 must be set to 1 or 2.)*

<b>Values</b>	Range	1:1 to 50:50
	Format:	<b>x</b> <b>y</b> <b>x</b> = the number of <b>above</b> echoes <b>y</b> = the number of <b>below</b> echoes
<b>Related</b>	P711 Echo Lock	

P711 default value		Description	P712 pre-set value
1		maximum verification	5: 5
2	*	material agitator	5: 2

### Example:

- Set P711 to **2** (material agitator)
- The preset values for P712 in this case are **5:2**
- Result: a new reading will not be validated unless 5 consecutive measurements higher or 2 consecutive measurements lower than the current reading occur.

**Note:** Resetting P711 returns P712 to the respective pre-set values.

## P713 Echo Lock Window

*Adjusts the size of the Echo Lock Window. This value is automatically altered when Measurement Response (P003), Maximum Fill Rate (P700), or Maximum Empty Rate (P701), are altered.*

<b>Values</b>	Range	0.000 to 9999
	Default	0.000
<b>Altered by</b>	P003 Measurement Response	
<b>Related Parameters</b>	P005 Units P711 Echo Lock	

The Echo Lock Window is a 'distance window'<sup>1</sup>, centered on the echo used to derive the reading. When a new measurement falls within the window, the window is re-centered and the new reading calculated. Otherwise, the new measurement is verified by Echo Lock (P711) before the reading is updated. The distance value of this parameter is given for a temperature of 20 °C (68 °F).

When the value is **0**, the window is automatically calculated after each measurement. The value is fixed at **0** if Echo Lock (P711) is set to **3**.

- For slower Measurement Response values (P003), the window is narrow.
- For faster P003 values the window becomes progressively wider.

**Note:** The echo lock window is stored as standard samples, but displayed in units based on P005. Any value entered for P713 will be rounded to the nearest sample.

## P752 HART address

Note: Accessible via the handheld programmer only by keying in P752.

*Sets the device address or poll ID on a HART network. Any address other than 0 will cause the output current to be a fixed value, and the current will not indicate the reading.*

<b>Values</b>	Range	<b>0 to 15</b>
---------------	-------	----------------

<sup>1</sup> Units are those set in P005.

# Communications (P799)

## P799 Communications Control

*Enables the read/write access to parameters via remote communications.*

<b>Values</b>	0		Read only
	1	*	Read/write
	2		Restricted access – read only except for P799 which is read/write

### Notes:

- P799 controls the access if you are using a HART master.
- P000 controls the lock access if you are using the Siemens handheld programmer.

## Echo Processing (P800 to P825)

*The following parameters are for authorized Siemens Service personnel or technicians familiar with Siemens echo processing techniques. View the echo profile first, before attempting to modify these parameters.*

### P800 Near Blanking <sup>1</sup>

*Defines the distance from the transducer face to be ignored by the transmitter/receiver.*

<b>Values</b>	Range (depends on model)	0.000 to 6.000 m (20 ft) or 0.000 to 12 m (40 ft) (units selected in P005)
	Default	0.250 m (0.820 ft)
<b>Related</b>	P006 Empty P007 Span P838 Auto False-Echo Suppression Distance	

To extend the blanking beyond the minimum default, enter a value in the units selected in P005.

<sup>1</sup>. For more details, see *Blanking Distance* on page 85.

## P801 Range Extension

**Note:** SITRANS Probe LU has an absolute maximum range of 7.2 m (23.6 ft). or 14.4 m (47.24 ft), depending on the model.

*Allows the material level to drop below Empty (process empty level), without generating an LOE state.*

<b>Values</b>	Range	0 to 25 (% or units)
	Default	20.000 (% of Span)
<b>Related</b>	P006 Empty P007 Span P838 Auto False-Echo Suppression Distance	

Use this feature if the surface monitored can drop below Empty level (P006) in normal operation. The value for P801 is added to Empty, and the sum can be greater than the range of the transducer. Range Extension can be increased (in Units or percent of Span) to a point where Empty plus Range Extension is greater than the distance from the transducer face to the furthest surface to be monitored. (The distance below empty is not blanked.)

- Enter the value as a percentage of P006.
- For vessels with conical or parabolic bottoms, increase the value for P801 to ensure that an empty vessel reads Empty.



## P804 Confidence Threshold

*Determines which echoes are evaluated by software.*

<b>Values</b>	Format	x:y x = short (range 0 to 99) y = long (range 0 to 99)
	Default	10:5
<b>Related Parameters</b>	P070 Failsafe Timer	

P804 sets the minimum echo confidence that the echo must meet in order to prevent a Loss of Echo condition and the expiration of the Failsafe timer (P070).

The short and long shot Confidence Thresholds are preset to 10 and 5 respectively. When Echo Confidence (P805) exceeds the Confidence Threshold, the echo is evaluated by Sonic Intelligence.

- Key in the value for the short shot, then press  (decimal point).
- Key in the value for the long shot, then press ENTER .

## P805 Echo Confidence

Measures echo reliability. It displays the echo confidence of the measurement echo from the last shot. P804 defines the minimum criterion for echo confidence.

<b>Values (view only)</b>	Format	x:y x = short (range 0 to 99) y = long (range 0 to 99)
	----	(Shot not used)
<b>Related Parameters</b>	P804 Confidence Threshold P830 TVT Type	

Press the measurement key  to get a new reading that will update confidence values.

Both short and long shot Echo Confidence values are displayed.

Display	Description
<b>x:--</b>	short shot confidence value, (long shot not used)
<b>--:y</b>	long shot confidence value, (short shot not used)
<b>x:y</b>	short and long shot confidence values (both used)
<b>E</b>	transducer cable is open or short circuited
<b>--:--</b>	no shots were processed for Sonic Intelligence evaluation

## P806 Echo Strength

Displays the absolute strength (in dB above 1  $\mu$ V rms) of the echo selected as the measurement echo.

<b>Values (view only)</b>	Display	<b>-20 to 112</b>
---------------------------	---------	-------------------

Press the measurement key  to get a new reading that will update echo strength.



## P807 Noise

*Displays the average and peak ambient noise of a noise profile (in dB above 1  $\mu$ V rms) as x.y. Noise level is a combination of transducer acoustic noise and receiving circuitry noise.*

<b>Values (view only)</b>	Format	x:y
		x = average (range: <b>-20 to 99</b> ) y = peak (range: <b>-20 to 99</b> )

After a measurement, the values from the previous noise shot will be displayed. Press the measurement key  to get a new reading that will update the noise profile.

## Algorithm (P820)

### P820 Algorithm

*Selects the algorithm to be applied to the echo profile to extract the true echo.*

<b>Values</b>	<b>3</b>		Largest echo (L)
	<b>4</b>		First echo (F)
	<b>8</b>	*	best of Largest or First echo (bLF)
	<b>12</b>		true First echo (tF)

For more clarification on the different options, please contact your local representative.

### P825 Echo marker

*The point on the primary echo on which the measured value is based. The value is entered in percent of echo height, which allows the Echo Lock Window to be set so that it intersects the Echo Profile at the sharpest rising portion of the Echo Profile.*

<b>Values</b>	Range	5 to 95%
	Default	50 (%)

# TVT (Time Varying Threshold) Adjustment Parameters (P830 to P839)

First SITRANS Probe LU learns the echo profile. Then the learned profile, or part of the learned profile, is used to screen out false echoes.<sup>1</sup>

The following parameters are for authorized Siemens Service personnel or technicians familiar with Siemens echo processing techniques. View the echo profile first, before attempting to modify these parameters.

## P830 TVT Type

Selects the TVT Curve used.

Values	1	*	TVT Short Curved
	2		TVT Short Flat
	3		TVT Long Flat
	4		TVT Long Smooth Front
	5		TVT Long Smooth
	6		TVT Slopes
Altered By	• P002 Material		
Related	• P805 Echo Confidence		

Select the TVT type which gives the highest confidence (P805) under all level conditions. Use this parameter with caution, and do not use TVT **Slopes** with the **F (First)** or **bLF (best of Largest or First echo)** Algorithm (P820).

## P831 TVT Shaper

**Note:** This parameter is for use by Siemens Service personnel.

Turns the TVT Shaper ON or OFF.

<sup>1</sup> For more detail, see *TVT (Time Varying Threshold) curves* on page 85.

## P832 TVT Shaper Adjust

**Note:** This parameter is for use by Siemens Service personnel.

*Allows manual adjustment of the TVT curve.*

## P837 Auto False-Echo Suppression

*Use P837 and P838 together, to set SITRANS Probe LU to ignore false echoes<sup>1</sup>. Use P838 to set the Auto TVT distance first.*

### Notes:

- This function works best when the vessel is empty or nearly empty: use it only if there is a minimum distance of 2 meters from the transducer face to the material.
- Set P837 and P838 during start up, if possible.
- If the vessel contains an agitator, the agitator should be running.

If SITRANS Probe LU displays a full level, or if the reading fluctuates between a false high level and a correct level, set P837 to elevate the TVT in this region and to de-sensitize the receiver from any 'base noise' caused by internal transducer reflections, nozzle echoes, or other vessel false echoes. Set P838 and then P837 (detailed instructions follow P838).

<b>Values</b>	<b>0</b>	*	Off
	<b>1</b>		Use 'learned' TVT. (See 'learned TVT curve' in <i>Display after Auto False Echo Suppression</i> on page 62.)
	<b>2</b>		Learn

### Display before Auto False Echo Suppression (or when P837 = 0)

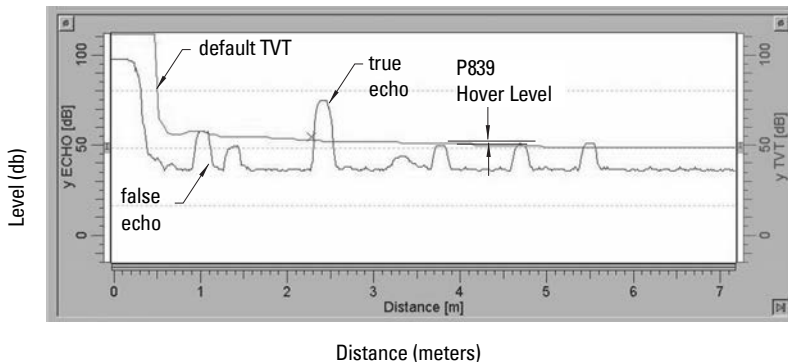

<sup>1</sup> For more detail, see *TVT (Time Varying Threshold) curves* on page 85.



## P838 Auto False-Echo Suppression Distance

Defines the range of Auto False-Echo Suppression (P837) to use for ignoring false echoes. (Units are defined in P005.)

<b>Values</b>	Range (depends on model)	Maximum range: 0.000 to 6.000 m (20 ft) or 0.000 to 12 m (40 ft)
	Default	1.000 m (3.28 ft)

Determine the actual distance from the transducer face to the material surface. Subtract 0.5 m from this distance, and enter the result.

### Set Up:

1. Perform this function when the vessel is empty or nearly empty.
2. Determine actual distance from transducer face to material level.
3. Select P838 and key in [distance to material level minus 0.5 m].
4. Press **ENTER** .
5. Select P837.
6. Press **2** and then press **ENTER** . P837 will revert to **1** (use Learned TVT) automatically after a few seconds.

### Display after Auto False Echo Suppression

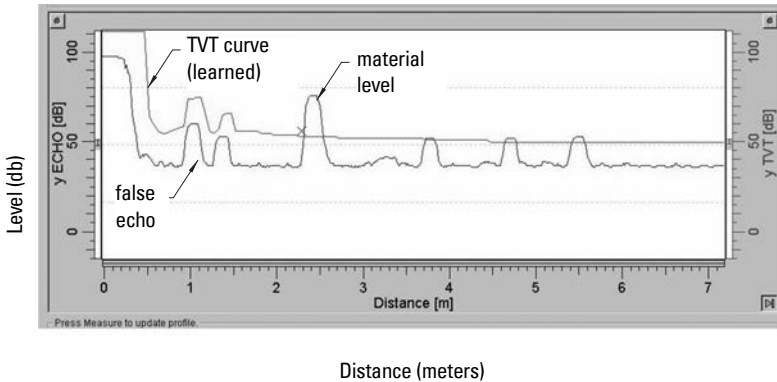

## P839 TVT Hover Level

*Defines (in percent) how high the TVT curve is placed above the profile, relative to the largest echo. When SITRANS Probe LU is located in the center of the vessel, lower this parameter to prevent multiple echo detections.*



<b>Values</b>	Range	<b>0 to 100%</b>
	Default	<b>33 (%)</b>

## Diagnostic Tests (P900 to P924)

### P900 Software Revision Number

*Displays the software revision level.*

<b>Values (view only)</b>	Range	<b>0.00 to 99.99</b>
<b>Secondary index</b>	1	Main code revision
	2	Primary boot revision
	3	Alternative boot revision
	4	Hardware stack revision
	Default	Determined by the software revisions installed

1. Select P900.
2. The secondary index number is visible in the auxiliary reading field.
3. Press **DISPLAY**  twice to focus control on the secondary index (the auxiliary reading field goes blank).
4. Key in the index number required, and press **ENTER** .
5. The software revision level associated with the new secondary index appears.
6. Press **DISPLAY**  twice and use the **ARROW** keys or enter the value for the next desired parameter.

## P901 Memory Test

Press **ENTER**  to activate the test.

<b>Values (view only)</b>	<b>IdLE</b>	Normal operation
	<b>PASS</b>	Memory test successful
	<b>F1</b>	Fail RAM
	<b>F2</b>	Fail EEPROM
	<b>F3</b>	Fail FLASH

## Measurement

### P911 mA Output Value

*Access this parameter to display the current value of the mA output.*

<b>Values (HART)</b>	Range	<b>3.6 to 22.6 (mA)</b>
	Default	4 mA in HART fixed current mode

1. Set P201 to **0** (manual).
2. Enter a test value.

**Note:** P201 must be set to **0** to enable the test value to be entered at P911: be sure to restore P201 to the previous setting after the test!

### P912 Temperature

*Displays the temperature in °C (as monitored by the connected transducer). This value is not affected by Temperature Source (P660).*

<b>Values (view only)</b>	Range	<b>-40 to 85 (°C)</b>
---------------------------	-------	-----------------------

## P920 Reading Measurement

P920 corresponds to the final reading after all programming is applied. It is a copy of one of P921 to P924, depending on the setting for Operation (P001).

Related parameters	Operation P001		Source Parameter for P920
	0	Off	----
	1	Level	P921 if P050 = 0, otherwise P924
	2	Space	P922
3	Distance	P923	
P920 Values (view only)	Range:		-99999 to 99999 (dimensional units, if volume has not been selected)

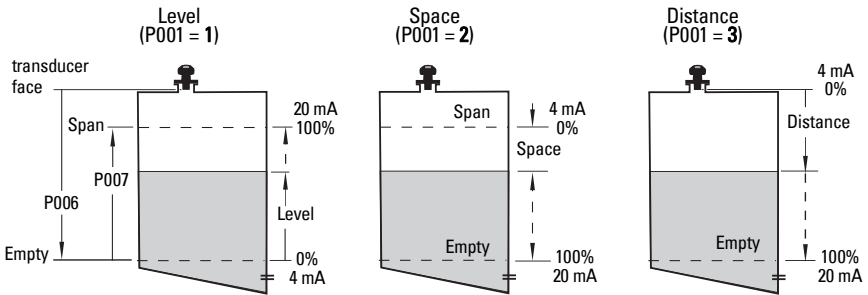

## P921 Material Measurement

Displays the distance between Empty /process empty level (P006) and the monitored surface, in Units (P005) or percent of Span (P007).

Values (view only)	Range	-99999 to 99999
--------------------	-------	-----------------

## P922 Space Measurement

Displays the distance between the monitored surface and Span / process full level (P007).

Values (view only)	Range	-99999 to 99999
--------------------	-------	-----------------

## P923 Distance Measurement

*Displays the distance between the monitored surface and the transducer face.*

<b>Values (view only)</b>	Range	-99999 to 99999
---------------------------	-------	-----------------

## P924 Volume (or Flow) Measurement

*The calculated vessel capacity in Maximum Volume (P051) or percent of Maximum Volume (volume calculation must be enabled at P050).*

<b>Values (view only)</b>	Range	: -99999 to 99999
	----	Display when volume calculation is not enabled at P050 (P050 = 0)
<b>Related Parameters</b>	P051 Maximum Volume P050 Vessel (or Channel) Shape	

## P999 Master Reset

**Note:** Following a Master Reset, complete reprogramming is required.

*Resets all parameters to their factory settings, with the following exceptions:*

- P000 and P069 are not reset.
- The learned TVT curve is not lost.

Use this feature after upgrading software:

1. Select P999.
2. Press **CLEAR** [c] then **ENTER** [↵] to Clear All and initiate reset.
3. Reset complete.

(**Note:** Reset takes several seconds to complete.)





# Appendix A: Alphabetical Parameter List

Parameter Name	Parameter Number	Page Number
20 mA Output Trim	215	46
20 mA Setpoint (high output)	211	45
4 mA Output Trim	214	46
4 mA Setpoint (low output)	210	44
Algorithm	820	59
Auto False Echo Suppression	837	61
Auto False Echo Suppression Distance	838	62
Communications Control	799	56
Confidence Threshold	804	57
Damping Filter	709	53
Distance Measurement	923	66
Echo Confidence	805	58
Echo Lock	711	53
Echo Lock Sampling	712	54
Echo Lock Window	713	55
Echo Marker Trigger	825	59
Echo Strength	806	58
Empty (process empty level)	006	33
Failsafe Level	073	43
Fail-Safe Material Level	071	42
Fail-Safe Timer	070	42
Internal Temperature	343	47
Language	010	34
Level (or Head) Breakpoints	054	37
Lock	000	30
mA Output Function	201	43
Maximum mA Limit	213	45
Minimum mA Limit	212	45

Parameter Name	Parameter Number	Page Number
mA Output Value	911	64
Master Reset	999	66
Material	002	32
Material Measurement	921	65
Maximum Empty Rate	701	52
Maximum Fill Rate	700	52
Maximum Volume	051	35
Measurement Response	003	32
Memory Test	901	64
Near Blanking	800	56
Noise	807	59
Offset Calibration	650	49
Offset Correction	652	49
Operation	001	31
Power-On Resets	342	47
Range Extension	801	57
Reading Measurement	920	64
RUN Time	341	46
Serial Number	346	48
Software Revision Number	900	63
Sound Velocity at 20 °C	654	51
Sound Velocity Calibration	651	49
Space Measurement	922	65
Span (process full level)	007	33
Temperature	664	52
Temperature	912	64
Temperature fixed	661	51
Temperature source	660	51
Temperature, transducer maximum	300	46

Parameter Name	Parameter Number	Page Number
TVT Hover Level	839	63
TVT Shaper	831	60
TVT Shaper Adjust	832	61
TVT Type	830	60
Units	005	33
Unlocked value	069	42
Velocity	653	50
Vessel Dimension 'A'	052	37
Vessel Dimension 'L'	053	37
Vessel Shape	050	35
Volume (or Flow) Breakpoints	055	40
Volume (or Flow) Measurement	924	66

# Appendix B: Programming Chart

Number	Parameter Name	Value
000	P000 Lock	
001	P001 Operation	
002	P002 Material to be monitored	
003	P003 Measurement Response	
005	P005 Units	
006	P006 Empty (process empty level)	
007	P007 Span (process full level)	
010	P010 Language	
050	P050 Vessel (or Channel) Shape	
051	P051 Maximum Volume	
052	P052 Vessel Dimension A	
053	P053 Vessel Dimension L	
054	P054 Level or Head Breakpoints	
055	P055 Volume or Flow Breakpoints	
069	P069 Unlocked value	
070	P070 Failsafe Timer	
071	P071 Failsafe Material Level	
073	P073 Failsafe level	
201	P201 mA Output Function	
210	P210 4 mA Setpoint (low output)	
211	P211 20 mA Setpoint (high output)	
212	P212 Minimum mA limit	
213	P213 Maximum mA limit	
214	P214 4 mA Output Trim	
215	P215 20 mA Output Trim	
300	P300 Temperature, transducer maximum	
341	P341 RUN Time	
342	P342 Power-On Resets	
343	P343 Internal Temperature	
650	P650 Offset Calibration	
651	P651 Sound Velocity Calibration	
652	P652 Offset Correction	

Number	Parameter Name	Value
653	P653 Velocity	
654	P654 Sound Velocity at 20 oC	
660	P660 Temperature source	
661	P661 Temperature fixed	
664	P664 Temperature	
700	P700 Maximum Fill Rate	
701	P701 Maximum Empty Rate	
709	P709 Damping Filter	
711	P711 Echo Lock	
712	P712 Echo Lock Sampling	
713	P713 Echo Lock Window	
799	P799 Communications Control	
800	P800 Near Blanking	
801	P801 Range Extension	
804	P804 Confidence Threshold	
805	P805 Echo Confidence	
806	P806 Echo Strength	
807	P807 Noise	
820	P820 Algorithm	
825	P825 Echo marker	
830	P830 TVT Type	
831	P831 TVT Shaper	
832	P832 TVT Shaper Adjust	
837	P837 Auto False-Echo Suppression	
838	P838 Auto False-Echo Suppression Distance	
839	P839 TVT Hover Level	
900	P900 Software Revision Number	
901	P901 Memory Test	
911	P911 mA Output Value	
912	P912 Temperature	
920	P920 Reading Measurement	
921	P921 Material Measurement	
922	P922 Space Measurement	

<b>Number</b>	<b>Parameter Name</b>	<b>Value</b>
923	P923 Distance Measurement	
924	P924 Volume (or Flow) Measurement	
999	P999 Master Reset	

# Appendix C: HART Communications

---

Highway Addressable Remote Transducer, HART, is an industrial protocol that rides on top of a 4-20 mA signal. It is an open standard, and full details about HART can be obtained from the HART Communication Foundation at [www.hartcomm.org](http://www.hartcomm.org)

SITRANS Probe LU can be configured over the HART network using either the HART Communicator, or a software package. There are a number of different software packages available, and the SITRANS Probe LU should work well with any of them. The recommended software package is the SIMATIC Process Device Manager (PDM) by Siemens.

## HART Electronic Device Description (EDD)

**Note:** SITRANS Probe LU (HART) cannot be configured using a generic EDD.

In order to configure a HART device, the configurator must have the HART Electronic Device Description for the device in question. HART EDD's are controlled by the HART Communication Foundation.

Please contact your local Siemens representative concerning the availability of the HART EDD for SITRANS Probe LU. Older versions of the library will have to be updated in order to use all the features in the SITRANS Probe LU.

# HART Communicator 275/375:

Chart 1

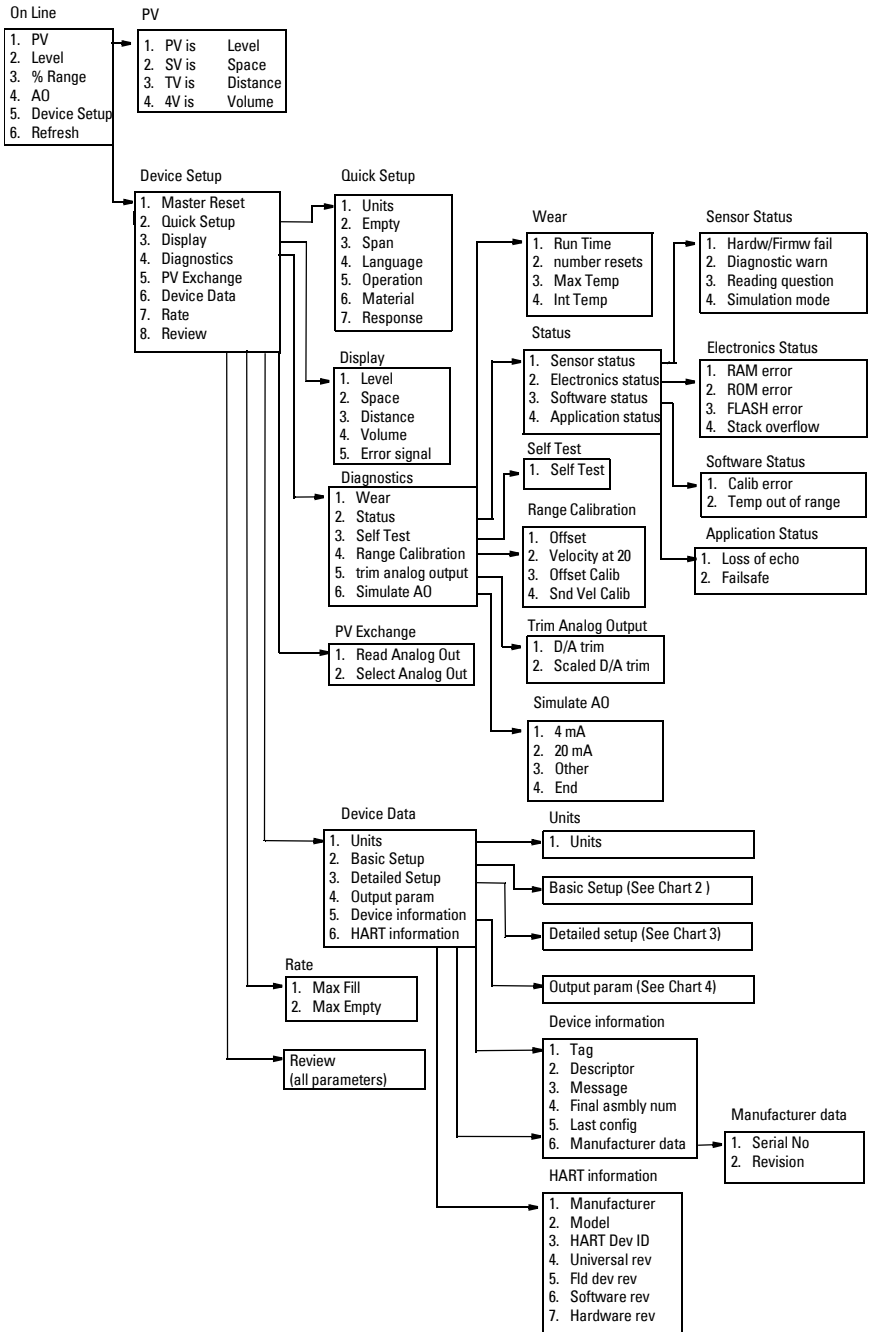

C: HART Communications



## Chart 2

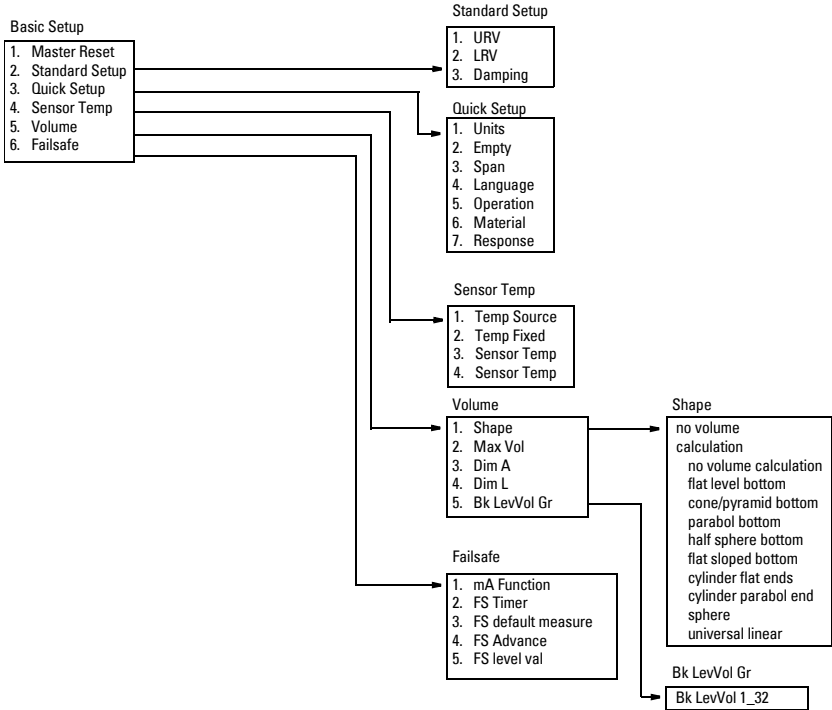

**Chart 3**

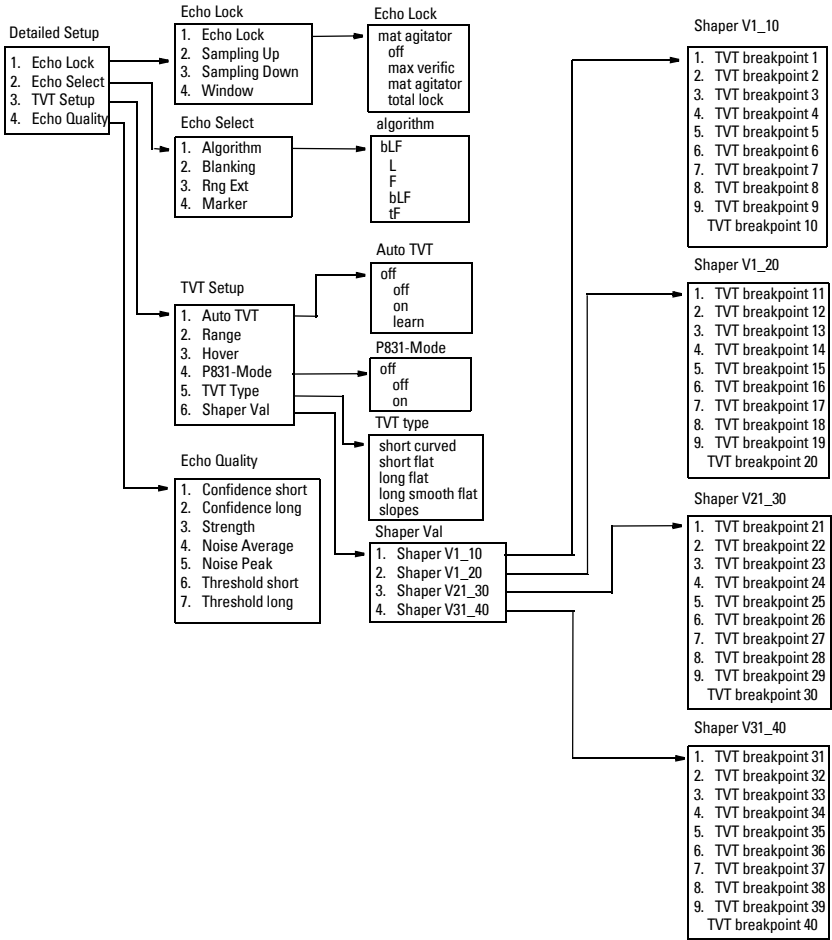

**Chart 4**

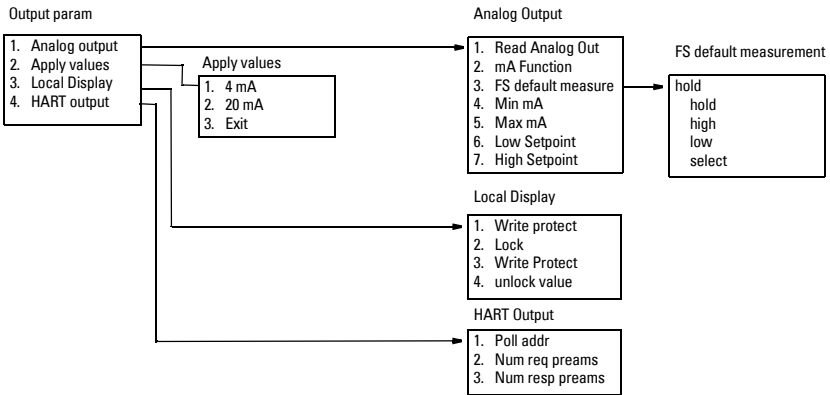

## SIMATIC Process Device Manager (PDM):

This software package is designed to permit easy configuration, monitoring and troubleshooting of HART devices. The HART DD for the SITRANS Probe LU was written with SIMATIC PDM in mind and has been extensively tested with this software.

The Device Description for SIMATIC PDM may be downloaded from the product page of our website at: <https://pia.khe.siemens.com/index.asp?Nr=11157>, under **Downloads**.

All parameters accessible via the HART Communicator are also accessible via PDM. In addition, the Maintenance parameters listed below are accessible via PDM only.

## Maintenance settings (accessible via PDM only)

### Device Lifetime

- Total Device Operating Time
- Remaining Device Lifetime
- Maintenance Required Limit
- Maintenance Demanded Limit
- Maintenance Alert Activation
- Total Expected Device Life
- Units
- Maintenance Status
- Acknowledge Status
- Acknowledge

## Sensor Lifetime

- Total Sensor Operating Time
- Remaining Sensor Lifetime
- Maintenance Required Limit
- Maintenance Demanded Limit
- Maintenance Alert Activation
- Total Expected Sensor Life
- Units
- Maintenance Status
- Acknowledge Status
- Acknowledge

## Service Interval

- Time Elapsed Since Last Service
- Maintenance Required Limit
- Maintenance Demanded Limit
- Maintenance Alert Activation
- Total Service Interval
- Units
- Maintenance Status
- Acknowledge Status
- Acknowledge

## Calibration Interval

- Time Elapsed Since Last Calibration
- Maintenance Required Limit
- Maintenance Demanded Limit
- Maintenance Alert Activation
- Total Calibration Interval
- Units
- Maintenance Status
- Acknowledge Status
- Acknowledge

## HART Version

The SITRANS Probe LU (HART) conforms to HART rev. 5.

## Burst mode

SITRANS Probe LU (HART) does not support burst mode.

## Multidrop Configuration

SITRANS Probe LU (HART) does not support multidrop configuration.

# Appendix D: Troubleshooting

---

## Communication Troubleshooting

### Generally:

1. Check the following:
  - There is power at the unit
  - The LCD shows the relevant data
  - The device can be programmed using the handheld programmer
2. Verify that the wiring connections are correct.

### Specifically:

If you try to set a SITRANS Probe LU parameter via remote communications, but the parameter remains unchanged:

- Some parameters can only be changed when the device is not scanning. Try putting the device in program mode using the operating mode function.
- Try setting the parameter from the keypad. (First make sure that the lock parameter [P000] is set to the value stored in P069.)
- The communications control parameter P799 must be set to **1** to be able to write parameters to SITRANS Probe LU.

# General Fault Code

**Note:** Some faults cause the device to go to Failsafe mode (Fault 52). These are indicated with an asterisk (\*).

Code		Meaning	Corrective Action
S:0	*	The device was unable to get a measurement within the Failsafe Timer period. Possible causes: faulty installation, antenna buildup, foaming/other adverse process conditions, invalid calibration range.	Ensure installation details are correct. Ensure no antenna buildup. Adjust process conditions to minimize foam or other adverse conditions. Correct range calibration. If fault persists, contact your local Siemens representative.
S:2	*	The device is operating in a low power condition that is outside its operating range. As a result, a valid measurement has not been taken for the failsafe timer period, and the device will be put into failsafe mode.	Correct the power supply (resistance or voltage).
S:3		Device is nearing its lifetime limit according to the value set in Maintenance Required Limit.	Replacement is recommended.
S:4		Device is nearing its lifetime limit according to the value set in Maintenance Demanded Limit.	Replacement is recommended.
S:6		Sensor is nearing its lifetime limit according to the value set in Maintenance Required Limit.	Replacement is recommended.
S:7		Sensor is nearing its lifetime limit according to the value set in Maintenance Demanded Limit.	Replacement is recommended.
S:8		Service interval as defined in Maintenance Required Limit has expired.	Perform service.
S:9		Service interval as defined in Maintenance Demanded Limit has expired.	Perform service.
S:11		Internal temperature sensor failure.	Repair required: contact your local Siemens representative.

<b>Code</b>	<b>Meaning</b>	<b>Corrective Action (cont'd)</b>
S:12	Internal temperature of device has exceeded specifications: it is operating outside its temperature range.	Relocate device and/or lower process temperature enough to cool device. Inspect for heat-related damage and contact your local Siemens representative if repair is required.
S:17	Calibration interval as defined in Maintenance Required Limit has expired.	Perform calibration.
S:18	Calibration interval as defined in Maintenance Demanded Limit has expired.	Perform calibration.
S:28	* Internal device failure caused by a RAM memory error.	Repair required: contact your local Siemens representative.
S:29	* EEPROM damaged.	Repair required: contact your local Siemens representative.
S:31	* Flash error.	Repair required: contact your local Siemens representative.
S:33	* Factory calibration for the internal temperature sensor has been lost.	Repair required: contact your local Siemens representative.
S:34	* Factory calibration for the device has been lost.	Repair required: contact your local Siemens representative.
S:35	* Factory calibration for the device has been lost.	Repair required: contact your local Siemens representative.
S:36	* Unable to start microwave module.	Reset power. If error persists, contact your local Siemens representative.
S:37	* Measurement hardware problem.	Reset power. If error persists, contact your local Siemens representative.
S:38	* Failure in the device electronics.	Reset power. If fault persists, contact your local Siemens representative: repair required.



<b>Code</b>	<b>Meaning</b>	<b>Corrective Action (cont'd)</b>
S:39 *	Transducer temperature sensor failure..	Reset power. If fault persists, contact your local Siemens representative: repair required.
S:40	Transducer temperature too high.	Relocate device and/or lower process temperature enough to cool device. Inspect for heat-related damage and contact your local Siemens representative if repair is required.
S:41	Transducer temperature too low.	Relocate device and/or raise process temperature enough to warm device. Inspect for damage and contact your local Siemens representative if repair is required.
S:42	Factory calibration for the transducer temperature sensor has been lost.	Repair required: contact your local Siemens representative.
S:43 *	Factory calibration for the radar receiver has been lost.	Repair required: contact your local Siemens representative.
S:44 *	Factory calibration for the echo slope has been lost.	Repair required: contact your local Siemens representative.
S:45 *	No valid boot program detected: firmware corrupt.	Repair required: contact your local Siemens representative.
S:48 *	User configuration is invalid. One or more of parameters: Span, Volume breakpoints, and/or Auto False-Echo Suppression, are set to invalid values.	Reconfigure the unit. Ensure Span (P007) is not set to 0; check the breakpoints (only required if P050 is set to 9); do a P999 reset.
S:49 *	EEPROM corrupt.	Repair required: contact your local Siemens representative.
S:50 *	EEPROM corrupt.	Repair required: contact your local Siemens representative.



Code	Meaning	Corrective Action (cont'd)
S:51 *	EEPROM corrupt.	Repair required: contact your local Siemens representative.
S:52	Failsafe is activated. Possible causes: 1) hardware failure; 2) memory failure; 3) Fault 48; 4) failsafe timer expired– possible causes: faulty installation, antenna buildup, foaming/ other adverse process conditions, invalid calibration range.	For 3) and 4) Correct configuration; ensure installation is correct; no antenna buildup; adjust process conditions to minimize foaming/ other adverse conditions; correct calibration range. If fault persists, or for 1) and 2), contact your local Siemens representative.
S:53 *	Configuration lost: one or more parameter settings have been lost. This may occur after a firmware upgrade causes user parameters to be reset.	Restore user parameters using SIMATIC PDM.

## Operation Troubleshooting

Operating symptoms and probable causes.<sup>1</sup>

Symptom	Meaning	Probable cause
status symbol flashes 	Failsafe timer starts running.	<ul style="list-style-type: none"> <li>material or object in contact with transducer face</li> <li>transducer face is too close to the fill point</li> <li>transducer face is not perpendicular to the liquid surface</li> <li>change in level too fast</li> <li>measurement out of range</li> <li>foam on liquid surface</li> <li>high level of vibration in the mounting structure</li> <li>level inside the blanking zone</li> </ul>
status symbol does not flash, and LOE alternates with reading 	The 'Waiting' period has expired.	

Refer to *P003 Measurement Response* on page 32, or *P070 Failsafe Timer* on page 42, for duration of 'Waiting' periods.

<sup>1</sup> For details on blanking, see *Blanking Distance* on page 85.

# Appendix E: Maintenance

---

SITRANS Probe LU requires no maintenance or cleaning.

## Unit Repair and Excluded Liability

All changes and repairs must be done by qualified personnel, and applicable safety regulations must be followed. Please note the following:

- The user is responsible for all changes and repairs made to the device.
- All new components must be provided by Siemens Process Instruments Inc.
- Restrict repair to faulty components only.
- Do not re-use faulty components.

## Principles of operation

The transducer emits a series of ultrasonic pulses: each pulse is reflected as an echo from the material and sensed by the transducer. The echo is processed by SITRANS Probe LU, using Siemens' proven Sonic Intelligence techniques. Filtering is applied to help discriminate between the true echo from the material, and false echoes from acoustic and electrical noises and agitator blades in motion.

The time for the pulse to travel to the material and back is temperature compensated and then converted into distance for display and mA output.

## Blanking Distance

The crystal which produces the transmit pulse has to stop vibrating before it can receive an echo. The blanking<sup>1</sup> distance is the space in front of the transducer face where level measurement is not possible, because within that distance, the echo would return before the vibration had ceased.

The reference point for measuring blanking distance is the transducer face. The minimum recommended blanking value is 0.25 m (10"), but this can be increased in order to extend the blanking.

## TVT (Time Varying Threshold) curves

A TVT curve describes a threshold below which any echoes will be ignored. The default TVT curve is used, until P837 and P838 are used to create a new 'learned TVT curve'.

## Auto False-Echo Suppression

False echoes can be caused by an obstruction in the beam path (pipes, ladders, chains, and such). Such false echoes may rise above the default TVT curve.

P838 allows you to set a distance, and P837 then instructs the Probe LU to 'learn' where the obstructions/false echoes are within that distance. The new TVT curve is set above the false echoes, screening them out.

---

<sup>1</sup> Also referred to as "Near Blanking".

## Display before Auto False Echo Suppression (or when P837 = 0)

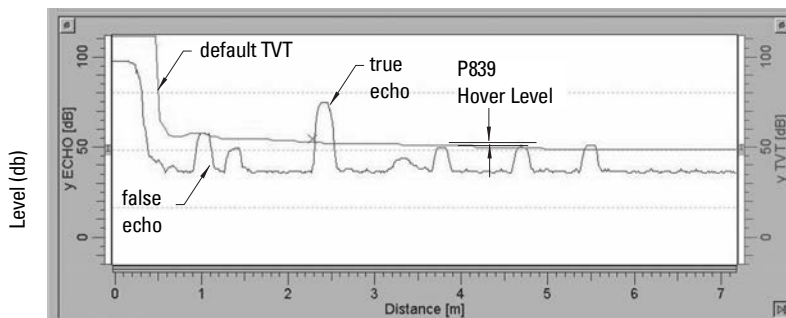

Distance (meters)

## Display after Auto False Echo Suppression

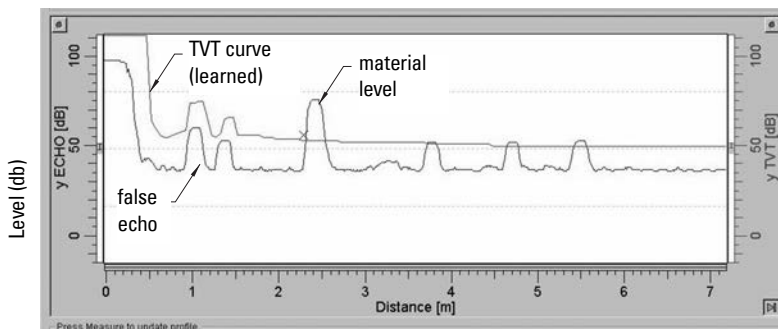

Distance (meters)

# Open Channel Monitoring (OCM)

OCM converts a level reading (head) into a flow value using a linear algorithm.

SITRANS Probe LU can convert a head level measurement into a flow rate, using a thirty-two breakpoint head-versus-flow characteristic curve. This chart is usually available from the manufacturer of the v-notch weir, Parshall flume, or other open channel device.

Parameter P050 must be set to 9 (universal linear function), and breakpoints must be set for head levels and corresponding flowrates at parameters P054 and P055. Once these parameters are set, the mA output is scaled to represent the flowrate, and the RUN mode display will show the flowrate

## Example: Flow Characterization.

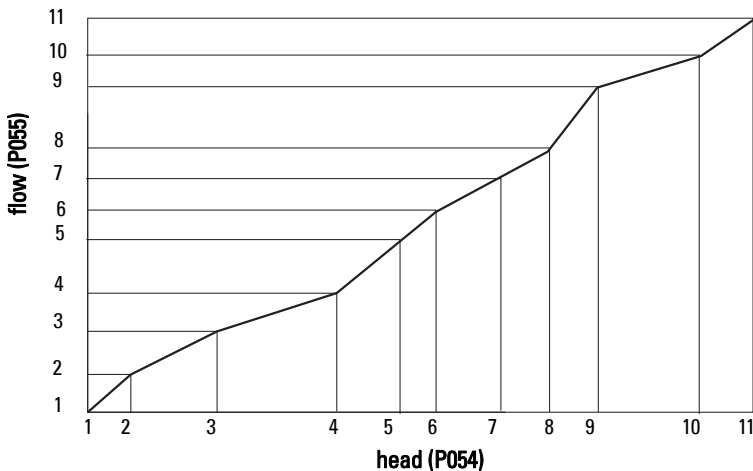

The maximum and minimum points on the curve must be defined. Then program the remaining breakpoints to closely match the flow curve of your open channel device.

## Failsafe

The Failsafe function can be activated either if there is not a valid measurement, or by one of the faults marked by an asterisk in the table *General Fault Code* on page 80. In Failsafe mode, the device will output one of the four options determined by P071 (Failsafe Material Level).

Failsafe Mode P071	
1 = HI	Use Maximum mA Limit (P213) as material level
2 = LO	Use Minimum mA Limit (P212) as material level
3 = HOLd	Level remains at last reading
4 = SEL	User-selected value (defined in P073)

If an invalid measurement is generated by the application (for example, material level outside threshold settings), the Failsafe timer (P070) will control the speed of the Failsafe response. When the Failsafe timer expires, the device outputs the value selected in P071. If a valid measurement is received before the timer expires, the timer will be reset.

If Failsafe mode is activated by a fault (see *General Fault Code* on page 80), the instrument will go into Failsafe mode without delay.

## Chemical compatibility

The plastic materials used in the construction of SITRANS Probe LU (ETFE, PBT, and PVDF) are resistant to attack from most chemicals. For exposure to specific environments, check with chemical compatibility charts before installing and operating SITRANS Probe LU in your application.

## Startup Behavior

### Notes:

- SITRANS Probe LU (HART) is designed to start reliably with a power supply capable of delivering at least 25 mA.
- When connected to a power supply with a current limit of < 25 mA, the Probe LU may not start reliably.

### Typical Startup Current

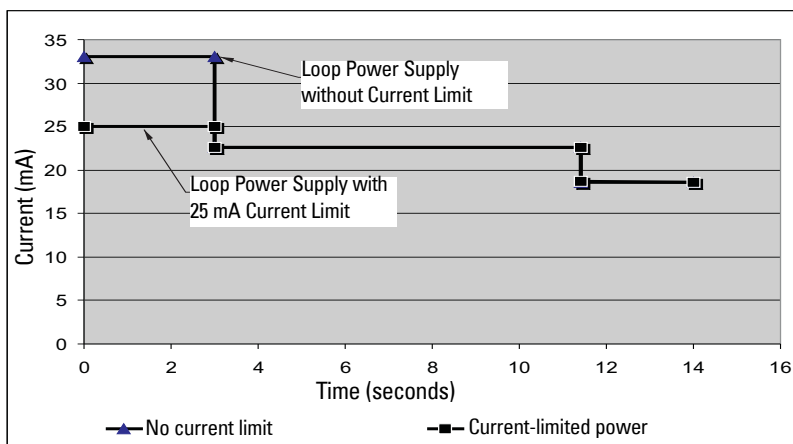

# Appendix G: Hazardous area installations

- Wiring details
- Instructions specific to hazardous area installations

## Wiring Details

### Intrinsically Safe Model

FM (reference drawing 23650516: see page 95)

CSA (reference drawing 23650517: see page 96)

Under the entity evaluation concept, SITRANS Probe LU has the following characteristics:

(input voltage) $U_i$	= 30 V DC (max.)
(input current) $I_i$	= 120 mA DC (max.)
(input power) $P_i$	= 0.8 W

Definition:

The Entity Concept allows interconnection of intrinsically safe apparatus to associated apparatus not specifically examined in such combination. The criteria for interconnection is that the voltage and current which intrinsically safe apparatus can receive and remain intrinsically safe, considering faults, must be equal to or greater than the output voltage ( $U_o$ ) and output current ( $I_o$ ) levels which can be delivered by the associated apparatus, considering faults and applicable factors. In addition, the maximum unprotected capacitance ( $C_i$ ) and Inductance ( $L_i$ ) of the intrinsically safe apparatus, including interconnecting wiring, must be equal to or less than the capacitance and inductance which can be safely connected to associated apparatus.

# FM/CSA

- Approved dust-tight and water-tight conduit seals are required for outdoor NEMA 4X / type 4X / NEMA 6, IP67, IP68 locations.
- The maximum voltage of the non-intrinsically safe apparatus must not exceed 250 V rms.
- Recommended intrinsically safe barriers are listed on page 91.

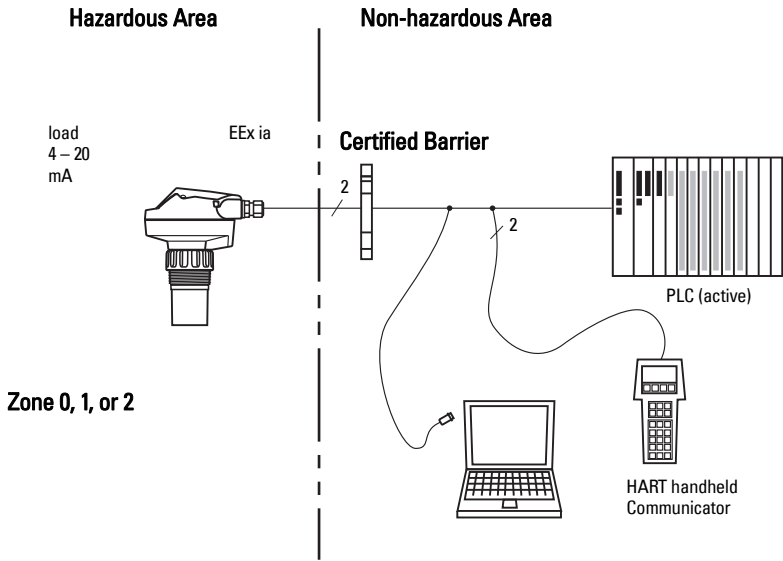

## EU Equivalency

Any zener diode safety barrier, certified by an EU approved certification body to [ EEx ia ] IIC, its output voltage ( $U_o$ ) not exceeding 30 V and its output current ( $I_o$ ) limited by load resistance ( $R_o$ ); such that  $I_o = U_o / R_o$ , does not exceed 120 mA.



# Loop Voltage versus Loop Resistance

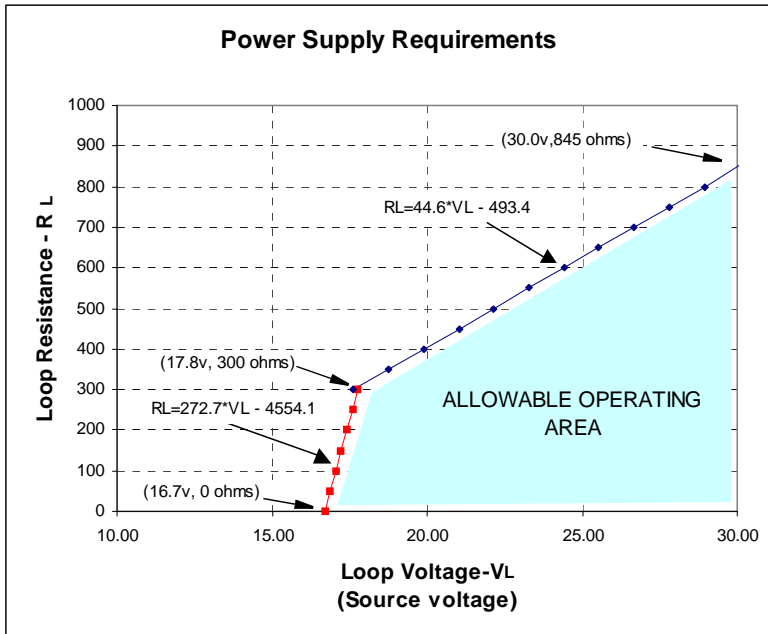

## IS Safety Barrier Selection

Selecting a suitable barrier or power supply requires knowledge about Intrinsic Safety and the application. It is the responsibility of the installer to ensure that the intrinsically safe installation complies with both the apparatus approval requirements and the relevant national code of practice.

### How to select a passive barrier for SITRANS Probe LU

1. Make sure that the barrier safety description is suitable for the SITRANS Probe LU Intrinsically Safe (IS) input parameters.
2. Determine the maximum end-to-end resistance of the barrier ( $R_{e-e}$ ) from the data sheet.
3. Determine other loop resistance ( $R_{loop}$ ): for example, sense resistance, displays, and/or PLC inputs.
4. Calculate  $R_{working} = R_{e-e} + R_{loop}$ .

5. Determine any non-linear voltage drops due to the barrier ( $V_{\text{barrier}}$ ) from the barrier data sheet (for example, voltage drops due to diodes).
6. Calculate  $V_{\text{working}} = V_{\text{supply}} - V_{\text{barrier}}$ .
7. Using  $V_{\text{working}}$  and  $R_{\text{working}}$ , confirm that operation is within the shaded area of the graph Loop Voltage versus Loop Resistance on page 91.

**Notes:**

- The following list is not complete: there are many safety barriers on the market, which will work with the SITRANS Probe LU.
- The barriers listed below have all been tested and are functionally compatible with the SITRANS Probe LU.
- The barriers listed below are all HART compatible.

## PLC Input Modules

Manufacturer	Part Number
Siemens	SM331 PCS7 HART Input Module

## Passive Shunt Diode Barriers

**Note:** A well regulated supply voltage is required.

Manufacturer	Part Number
MTL	7787P+ (Dual channel)
Stahl	9001/01-280-100-10 (Single channel)
Stahl	9002/01-280-110-10 (Dual channel)

## Active barriers (repeating barriers)

Manufacturer	Part Number
Siemens	7NG4122-1AA10
MTL	706
MTL	7206
Stahl	9001/51-280-110-14

# Wiring setups for hazardous area installations

Always check the device nameplate and process device tag to verify the approval rating.

## 1. Intrinsically Safe wiring

### Device nameplate (ATEX/IECEX/INMETRO/C-TICK)

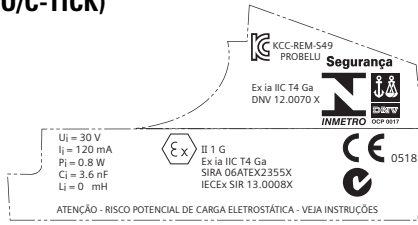
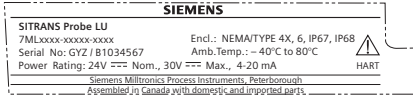

The ATEX certificate can be downloaded from the product page of our website at: [www.siemens.com/probelu](http://www.siemens.com/probelu). Go to **Support > Approvals / Certificates**.

The IECEX certificate listed on the nameplate can be viewed on the IECEX website. Go to: <http://iecx.iec.ch> and click on **Ex Equipment Certificates of Conformity** then enter the certificate number IECEX SIR 13.008X.

### Device nameplate (FM/CSA)

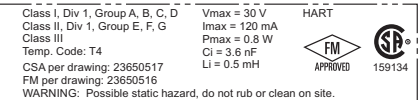
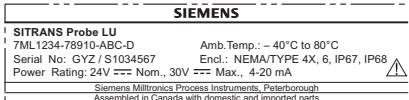

FM Intrinsically Safe connection drawing number **23650516**, and CSA Intrinsically Safe connection drawing number **23650517** can be downloaded from the product page of our website at: [www.siemens.com/probelu](http://www.siemens.com/probelu). Go to **Support > Installation Drawings > Level Measurement > Continuous - Ultrasonic**.

- For power demands see “Loop Voltage versus Loop Resistance” on page 91.
- For wiring requirements: follow local regulations.
- Approved dust-tight and water-tight conduit seals are required for outdoor Type 4X / NEMA 4X, Type 6 / NEMA 6, IP67, IP68 locations.
- Refer to “Instructions specific to hazardous area installations (Reference European ATEX Directive 94/9/EC, Annex II, 1/0/6)” on page 94.

## 2. Non-incendive wiring (FM US only)

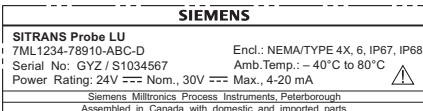

Class I, Div. 2,  
Group A, B, C, D  
Temp. Code: T5

FM Class 1, Div 2 connection drawing number **23650583** can be downloaded from the product page of our website at: [www.siemens.com/probelu](http://www.siemens.com/probelu). Go to **Support > Installation Drawings > Level Measurement > Continuous - Ultrasonic**.

- For power demands, see “Loop Voltage versus Loop Resistance” on page 91 of Appendix A.

# Instructions specific to hazardous area installations

(Reference European ATEX Directive 94/9/EC, Annex II, 1/0/6)

The following instructions apply to the SITRANS Probe LU covered by certificate number SIRA 06ATEX2355X:

1. For use and assembly, refer to the main instructions.
2. The equipment is certified for use as Category 1G equipment.
3. The equipment may be used with flammable gases and vapors with apparatus groups IIA, IIB, and IIC, and temperature classes T1, T2, T3, and T4.
4. The equipment is certified for use in an ambient temperature range of  $-40\text{ }^{\circ}\text{C}$  to  $+80\text{ }^{\circ}\text{C}$ .
5. The equipment has not been assessed as a safety related device (as referred to by Directive 94/9/EC Annex II, clause 1.5).
6. Installation and inspection of this equipment shall be carried out by suitably trained personnel in accordance with the applicable code of practice (EN 60079-14 and EN 60079-17 in Europe).
7. Repair of this equipment shall be carried out by suitably trained personnel in accordance with the applicable code of practice (e.g. EN 60079-19 within Europe).
8. Components to be incorporated into or used as replacements in the equipment shall be fitted by suitably trained personnel in accordance with the manufacturer's documentation.
9. It is the responsibility of the user to ensure that manual override is possible in order to shut down the equipment and protective systems incorporated within automatic processes which deviate from the intended operating conditions, provided that this does not compromise safety.
10. The 'X' suffix to the certificate number relates to the following special conditions for safe use:

Parts of the enclosure may be non-conducting and may generate an ignition-capable level of electrostatic charge under certain extreme conditions. The user should ensure that the equipment is not installed in a location where it may be subjected to external conditions (such as high-pressure steam) which might cause a build-up of electrostatic charge on non-conducting surfaces.

11. If the equipment is likely to come into contact with aggressive substances, then it is the responsibility of the user to take suitable precautions that prevent it from being adversely affected, thus ensuring that the type of protection is not compromised.

Aggressive substances: e.g. acidic liquids or gases that may attack metals, or solvents that may affect polymeric materials.

Suitable precautions: e.g. regular checks as part of routine inspections or establishing from the material's data sheet that it is resistant to specific chemicals.

## 12. Equipment Marking:

The equipment marking contains at least the information on the product nameplate, shown on page 93.



# CSA Intrinsically Safe connection drawing

**Note:** Reference drawing 23650517 is available from the product page of our website at: [www.siemens.com/probelu](http://www.siemens.com/probelu).

## G: Hazardous Installation

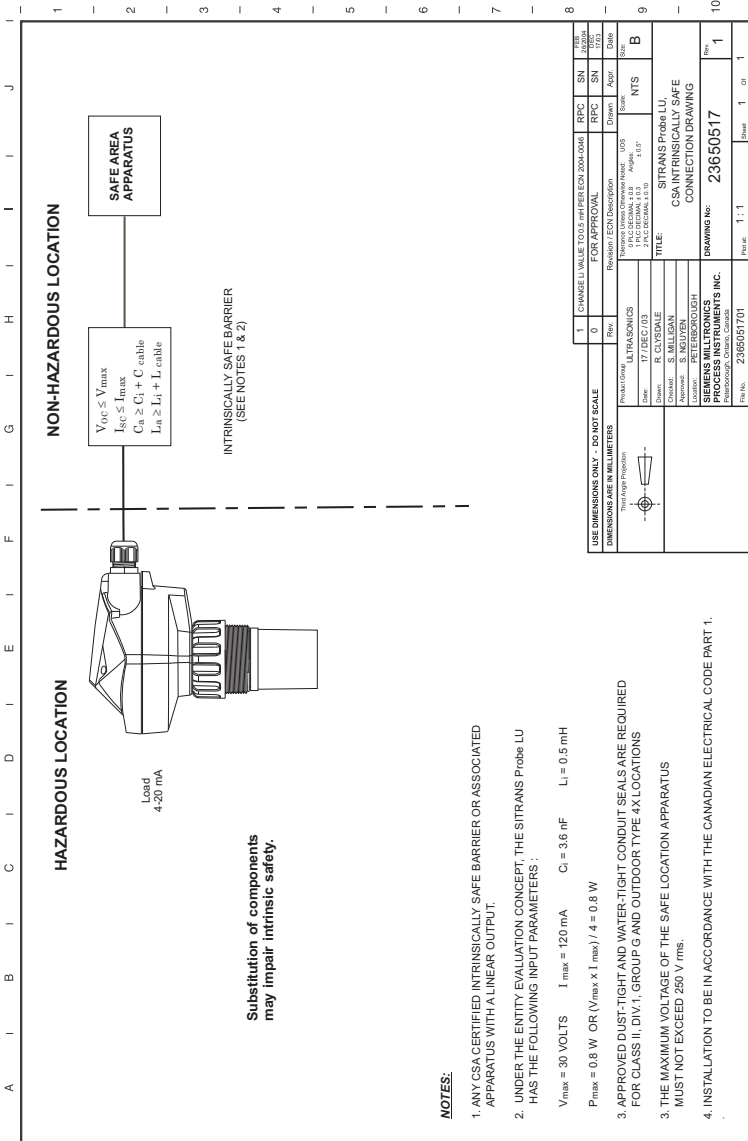

# FM Class 1, Div. 2 connection drawing

**Note:** Reference drawing 23650583 is available from the product page of our website at: [www.siemens.com/probelu](http://www.siemens.com/probelu).

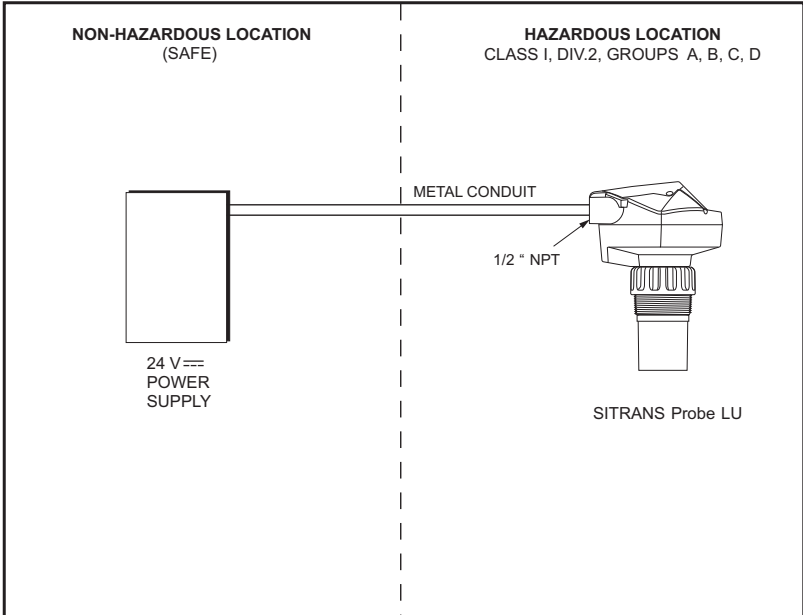

**NOTES:**

- 1) INSTALLATION SHALL BE DONE IN ACCORDANCE WITH THE NATIONAL ELECTRICAL CODE.
- 2) USE APPROVED WATER TIGHT CONDUIT FITTINGS FOR OUTDOOR APPLICATIONS.
- 3) FOR FURTHER INFORMATION REFER TO THE SITRANS Probe LU INSTRUCTION MANUAL

		1					
USE DIMENSIONS ONLY - DO NOT SCALE		0	FOR CONSTRUCTION		RPC	SN	SEPT 29/2004
DIMENSIONS ARE IN INCHES		Rev.	Revision / ECN Description		Drawn	Appr.	Date
	Product Group	ULTRASONICS			Tolerance Unless Otherwise Noted: UOS	Scale:	Size:
	Date:	29 / SEPT / 2004			1 Place Decimal ± 0.03	Angles: ± 0.5°	NTS
	Drawn:	R. CLYSDALE			<b>TITLE:</b> SITRANS Probe LU CLASS I, Div. 2 CONNECTION DRAWING		
	Checked:	S. MILLIGAN					
	Approved:	S. NGUYEN					
	Location:	PETERBOROUGH					
<b>SIEMENS MILLTRONICS PROCESS INSTRUMENTS INC.</b> Peterborough, Ontario, Canada		<b>DRAWING No:</b> 23650583		Rev:	0		
File No. 2365058300		Plot at: 1 : 1		Sheet 1	Of 1		

**G: Hazardous Installation**

# Appendix H: Firmware Revision History

---

Firmware Rev.	DD Rev.	Date	Changes
1.00	1.00	04 Jun 2004	
2.01	2.01.01	23 Sept 2005	<ul style="list-style-type: none"><li>• Increased breakpoints to 32.</li><li>• MP&amp;F parameters added to product.</li><li>• Fault system upgraded to use S# fault codes.</li></ul>
2.02	2.01.06	4 May 2008	<ul style="list-style-type: none"><li>• Maintenance release</li></ul>
2.03	2.01.06	9 Sept 2008	<ul style="list-style-type: none"><li>• Internal release</li></ul>
2.04	2.01.06	25 May 2013	<ul style="list-style-type: none"><li>• Maintenance release</li></ul>

H: Firmware revision



# Glossary

---

**acoustic noise:** any undesired audible sound.

**accuracy:** degree of conformity of a measure to a standard or a true value.

**agitator:** mechanical apparatus for mixing or aerating. A device for creating turbulence.

**algorithm:** a prescribed set of well-defined rules or processes for the solution of a problem in a finite number of steps.

**ambient temperature:** the temperature of the surrounding air that comes in contact with the enclosure of the device.

**attenuation:** a term used to denote a decrease in signal magnitude in transmission from one point to another. Attenuation may be expressed as a scalar ratio of the input magnitude to the output magnitude or in decibels.

**Auto False-Echo Suppression:** a technique used to adjust the level of a TVT curve to avoid the reading of false echoes. (See TVT.)

**Auto False-Echo Suppression Distance:** defines the endpoint of the TVT distance. (See TVT.) This is used in conjunction with auto false echo suppression.

**beam angle:** the angle diametrically subtended by the one-half power limits (-3 dB) of the sound beam.

**beam spreading:** the divergence of a beam as it travels through a medium.

**blanking:** the distance in front of the transducer face where level measurement is not possible.

**capacitance:** the property of a system of conductors and dielectrics that permits the storage of electricity when potential differences exist between the conductors. Its value is expressed as the ratio of a quantity of electricity to a potential difference, and the unit is a Farad.

**confidence:** describes the quality of an echo. Higher values represent higher quality. Confidence threshold defines the minimum value.

**damping:** term applied to the performance of an instrument to denote the manner in which the measurement settles to its steady indication after a change in the value of the level.

**dB (decibel):** a unit used to measure the amplitude of signals.

**derating:** to decrease a rating suitable for normal conditions according to guidelines specified for different conditions.

**dielectric:** a nonconductor of direct electric current.

**echo:** a signal that has been reflected with sufficient magnitude and delay to be perceived in some manner as a signal distinct from that directly transmitted. Echoes are frequently measured in decibels relative to the directly transmitted signal.

**echo confidence:** the recognition of the validity of the echo. A measure of echo reliability.

**Echo Lock Window:** a window centered on an echo in order to locate and display the echo's position and true reading. Echoes outside the window are not immediately processed.

**Echo Marker:** a marker that points to the processed echo.

**Echo Processing:** the process by which the radar unit determines echoes.

**Echo Strength:** describes the strength of the selected echo in dB above 1  $\mu$ V rms.

**Echo Profile:** a graphical display of a processed echo.

**electrical noise:** unwanted electrical signals that produce undesirable effects in the circuits of the control systems in which they occur.

**false echo:** any echo which is not the echo from the desired target. Generally, false echoes are created by vessel obstructions.

**frequency:** the number of periods occurring per unit time. Frequency may be stated in cycles per second.

**hertz (Hz):** unit of frequency, one cycle per second. 1 kilohertz (kHz) is equal to  $10^3$  Hz.

**HART:** Highway Addressable Remote Transducer. An open communication protocol used to address field instruments.

**inductance:** the property of an electric circuit by virtue of which a varying current induces an electromotive force in that circuit or in a neighboring circuit. The unit is a Henry.

**multiple echoes:** secondary echoes that appear as double, triple, or quadruple echoes in the distance from the target echo.

**Near Blanking:** see Blanking

**nozzle:** a length of pipe mounted onto a vessel that supports the flange.

**parameters:** in programming, variables that are given constant values for specific purposes or processes.

**pulse:** a wave that departs from an initial level for a limited duration of time, and returns to the initial level.

**range:** distance between a transmitter and a target.

**range extension:** the distance below the zero percent or empty point in a vessel.

**repeatability:** the closeness of agreement among repeated measurements of the same variable under the same conditions.

**shot:** one transmit pulse or measurement.

**stillpipe:** a pipe that is mounted inside a vessel parallel to the vessel wall, and is open to the vessel at the bottom.

**stilling-well:** see **stillpipe**.

**TVT (time varying threshold):** a time-varying curve that determines the threshold level above which echoes are determined to be valid.

**ultrasonic:** having a frequency above the human ear's audibility limit: about 20,000 hertz.

# Notes

---

# Index

---

## A

- Abbreviations and Identifications
  - list 2
- accuracy 6
- agitator blade detection
  - avoiding 54
- agitators 54
- algorithm
  - select for true echo 59
- Approvals 9
- ARROW keys
  - primary/secondary index function 30
- Auto False-Echo Suppression
  - instructions 61

## B

- blanking 85
  - extending 56
- breakpoints
  - level 37
  - volume 40

## C

- changing parameter values 22

## D

- damping 53
- default values
  - factory settings 29
- dimensions 13
- distance measurement 31

## E

- echo confidence
  - display 17
  - set threshold 57
- echo confidence reading 58
- echo strength
  - update 58
- echo verification 32

## F

- factory settings 29
  - default values 29
- Failsafe parameters 42
- false echo suppression
  - instructions 61
- false-echo suppression
  - setting 61
- function keys (RUN)
  - display echo confidence 17

## H

- hand programmer
  - access to SITRANS Probe LU 19
  - detailed instructions 20
- hazardous area installations
  - wiring requirements 93

## I

- Identifications and Abbreviations
  - list 2
- installation
  - hazardous area requirements 93

## L

- language
  - selection 22
- level measurement 31
- lock value 42
- Loop Voltage versus Loop Resistance 91
- loop voltage vs. loop resistance
  - power supply requirements 93

## M

- maintenance 84
- master reset 21, 66
- material mixers 54
- measurement mode 22
- multidrop configuration 78

## N

- near blanking
  - extending 56
  - see also blanking 85
- Noise parameter 59

## O

- operation
  - measurement modes 31

## P

- parameter
  - accessing 20
  - changing value 20
- parameter reset
  - factory default 20
  - master reset 21
- PDM 77
- percent or units 21
- power supply requirements
  - loop voltage vs. loop resistance 91, 93
  - specifications 6
- primary index 29

- accessing 29
- changing a value 29
- principles of operation 85
- programming chart 70

## **Q**

- quick start programming
  - instructions 22
  - setup steps 21

## **R**

- range extension 57
- repair 84
- reset parameters
  - factory default 20
  - master reset 21

- resistance

- loop voltage vs. loop resistance 91

## **S**

- safety barrier selection 91
- secondary index 29
  - accessing 30
  - changing value 30

- security

- lock value 42
  - unlock value 42

- setup instructions

- quick start programming 22

- SIMATIC Process Device Manager 73

- SIMATIC Process Device Manager (PDM) 77

- software revision number 63

- space measurement 31

## **T**

- temperature specification

- Ambient/Operating 11

## **U**

- units or percent 21

- unlock value 42

## **V**

- vessel shape

- conical bottoms 57
  - parabolic bottoms 57
  - selection 36

- voltage

- loop voltage vs. loop resistance 91

- volume measurement 31

- volume parameters 34

## **W**

- wire gauge 14

## **Z**

- zener diode safety barriers 90



## For more information

[www.siemens.com/level](http://www.siemens.com/level)

[www.siemens.com/weighing](http://www.siemens.com/weighing)

Siemens AG  
Industry Sector  
1954 Technology Drive  
P.O. Box 4225  
Peterborough, ON  
Canada K9J 7B1

email: [techpubs.smpi@siemens.com](mailto:techpubs.smpi@siemens.com)

[www.siemens.com/processautomation](http://www.siemens.com/processautomation)

Subject to change without prior notice  
A5E32337695 Rev. AA

© Siemens AG 2013



A 5 E 3 2 3 3 7 6 9 5  
Printed in Canada