

# MULTICAL® 602

## DATA SHEET

- Complete range of communication modules
- High Power RadioRouter module
- Data loggers
- Info loggers
- Data backup in case of power failure

EN 1434 MID-2004/22/EC

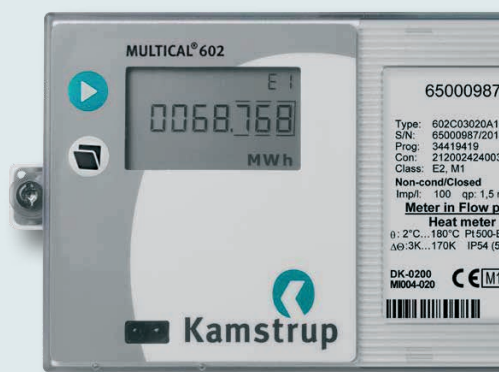
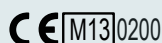

## Heat and cooling meters with unlimited communication

### Application

MULTICAL® 602 is an all-purpose energy calculator for heat and cooling together with almost any kind of pulsed flow sensors and with 2 or 4 wired temperature sensor pairs. Used together with Kamstrup ultrasonic flow sensor ULTRAFLOW®, even more advanced functions are available. On account of its pinpoint accuracy the meter registers precise consumption throughout the whole lifetime of the meter. The meter is maintenance-free and has a long lifetime which guarantees minimum yearly operating costs.

MULTICAL® 602 is used for heat, cooling and combined heat /cooling measurement in all water-based systems with temperatures from 2 °C to 180 °C for heat and 2 °C to 50 °C for cooling.

### Functionality

MULTICAL® 602 is used as heat meter together with the flow sensor, ULTRAFLOW® 54 and two temperature sensors. Flow sizes range from qp 0.6 m³/h to 1,000 m³/h. In cooling applications up to qp 100 m³/h the meter is connected to ULTRAFLOW® 14

and temperature sensors, whereas the meter is used together with ULTRAFLOW® 54 in cooling applications from qp 150 m³/h to qp 1,000 m³/h. The calculator can be used with flow parts up to qp 3,000 m³/h.

MULTICAL® 602 is characterized by its complete range of communication modules and integral RTC (Real Time Clock), which make it easy to fit the meter into all applications independent of reading type. The meter can be fitted with LON, SIOX, M-Bus, a data module and the solutions BACnet MS/TP, Metasys N2 and Ethernet/IP for wired communication. If the meter is to be integrated in a wireless network, you can select radio, Wireless M-Bus, ZigBee, or options like GSM/GPRS, 3G GSM/GPRS or High-Power RadioRouter with High-Power supply.

The calculator's info codes and data loggers make up an invaluable tool for troubleshooting, error correction and analysis of energy consumption. The info logger constantly monitors a number of key functions in the meter, such as error in measuring system,

power failure, leak, burst, or mounting of sensor in wrong flow direction. In such cases a flashing "INFO" and an info code appear in the display.

MULTICAL® 602 saves consumption data on a yearly, monthly, daily and hourly basis, which provides the operations manager with a complete performance analysis.

### Operations optimisation

In case of power failure data is backed up, thus securing billing of consumption data. If the meter is supplied with battery, the battery lifetime has been considerably increased – up to 13 years incl. Wireless M-Bus.

Finally, MULTICAL® 602 with ULTRAFLOW® and the precisely matched temperature sensors guarantee accurate measuring results even at minimal temperature differences. The flow sensor's long-term stability and accuracy are not influenced by flow velocity, flow disturbances or wear, which ensures an optimal operation.

### Reading Office

Cutbush Park, Danehill, Lower Earley,  
Reading, Berkshire. RG6 4UT. UK.  
Tel: +44 (0)118 9311188  
Email: info@able.co.uk

### Aberdeen Office

Unit 6 Airside Business Park, Kirkhill Industrial Estate,  
Dyce, Aberdeen. AB21 0GT. UK.  
Tel: +44 (0)1224 725999  
Email: ab@able.co.uk

Internet: www.able.co.uk  
e-procurement: www.247able.com  
Registered in England No: 01851002  
VAT No: GB 417 2481 61



## MULTICAL<sup>®</sup> 602 DATA SHEET

### Content

---

Calculator functions	3
Pulse outputs and pulse inputs of the modules	10
Cabinet design	11
Approved meter data	12
Electrical data	12
Mechanical data	15
Materials	15
Order specifications	16
Tolerance band	17
Dimensional sketches	18
Accessories	20

#### Reading Office

Cutbush Park, Danehill, Lower Earley,  
Reading, Berkshire. RG6 4UT. UK.  
Tel: +44 (0)118 9311188  
Email: info@able.co.uk

#### Aberdeen Office

Unit 6 Airside Business Park, Kirkhill Industrial Estate,  
Dyce, Aberdeen. AB21 0GT. UK.  
Tel: +44 (0)1224 725999  
Email: ab@able.co.uk

Internet: [www.able.co.uk](http://www.able.co.uk)  
e-procurement: [www.247able.com](http://www.247able.com)  
Registered in England No: 01851002  
VAT No: GB 417 2481 61



## MULTICAL® 602 DATA SHEET

### Calculator functions

#### Energy calculation

MULTICAL® 602 calculates energy based on the formula in prEN 1434-1:2009, in which the international temperature scale from 1990 (ITS-90) and the pressure definition of 16 bar is used.

The energy calculation can in a simplified way be expressed as:

$$\text{Energy} = V \times \Delta\Theta \times k.$$

V is the supplied water volume

$\Delta\Theta$  is the temperature difference measured

k is the thermal coefficient of water

The calculator always calculates energy in [Wh], and then it is converted into the selected measuring unit.



E [Wh] =	$V \times \Delta\Theta \times k \times 1000$
E [kWh] =	$E [\text{Wh}] / 1.000$
E [MWh] =	$E [\text{Wh}] / 1.000.000$
E [GJ] =	$E [\text{Wh}] / 277.780$
E [Gcal] =	$E [\text{Wh}] / 1.163.100$

#### Application types

MULTICAL® 602 operates with 9 different energy formulas, E1...E9, that are all calculated in parallel in connection with each integration no matter how the meter is configured.

The energy types E1 to E9 are calculated as follows:

$$E1 = V1(T1 - T2)k \quad \text{Heat energy (V1 in inlet or outlet)}$$

$$E2 = V2(T1 - T2)k \quad \text{Heat energy (V2 in outlet)}$$

$$E3 = V1(T2 - T1)k \quad \text{Cooling energy (V1 in inlet or outlet)}$$

$$E4 = V1(T1 - T3)k \quad \text{Inlet energy}$$

$$E5 = V2(T2 - T3)k \quad \text{Outlet energy or tapping from outlet}$$

$$E6 = V2(T3 - T4)k \quad \text{Tap water energy, separate}$$

$$E7 = V2(T1 - T3)k \quad \text{Tap water energy, inlet pipe}$$

$$E8 = m^3 \times T1 \quad \text{Basis for calculating volume based average temperatures in inlet T1}$$

$$E9 = m^3 \times T2 \quad \text{Basis for calculating volume based average temperatures in outlet T2}$$

This renders MULTICAL® 602 capable of calculating the heat and cooling energy of most applications, both closed and open systems.

All energy types are data logged and can be displayed dependent of configuration.

#### Reading Office

Cutbush Park, Danehill, Lower Earley,  
Reading, Berkshire. RG6 4UT. UK.  
Tel: +44 (0)118 9311188  
Email: info@able.co.uk

#### Aberdeen Office

Unit 6 Airside Business Park, Kirkhill Industrial Estate,  
Dyce, Aberdeen. AB21 0GT. UK.  
Tel: +44 (0)1224 725999  
Email: ab@able.co.uk

Internet: [www.able.co.uk](http://www.able.co.uk)  
e-procurement: [www.247able.com](http://www.247able.com)  
Registered in England No: 01851002  
VAT No: GB 417 2481 61



## MULTICAL® 602 DATA SHEET

### Calculator functions

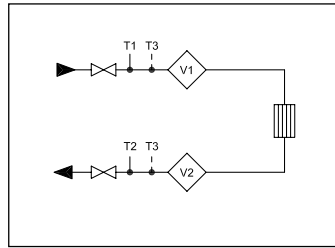

Example 1:  
Closed thermal system with 1 or 2 flow sensors

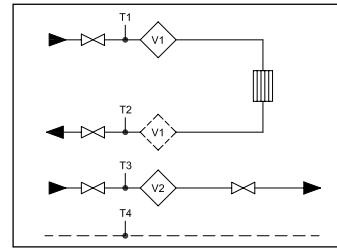

Example 2:  
2 string system with 2 flow sensors

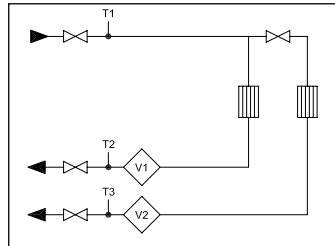

Example 3:  
2 heat circuits with joint flow

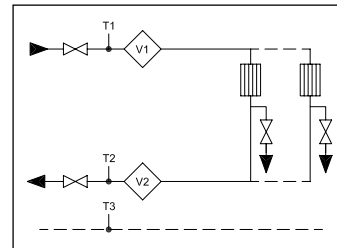

Example 4:  
Open system with 2 flow sensors

### Flow measurement

MULTICAL® 602 calculates current water flow according to two different principles depending on the connected flow sensor type:

- The flow indication of electronic flow meters is updated every 10 seconds.
- The flow indication of mechanical flow meters, typically with reed contact, is calculated on the basis of periodic time measurement and is updated with each volume pulse.

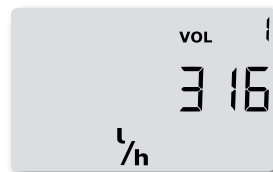

## MULTICAL® 602 DATA SHEET

### Calculator functions

#### Power measurement

MULTICAL® 602 calculates current power on the basis of current water flow and the temperature difference measured in connection with the latest integration.

Current power is updated in the display simultaneously with the flow update.



#### Min. and max. flow and power

MULTICAL® 602 registers minimum and maximum flow and power on a monthly as well as on a yearly basis. The registrations which appear from the display or can be read via data communication include max. and min. flow and power values, all with date indication.

All max. and min. values are calculated as largest and smallest average respectively of a number of current flow or power measurements. The average period used for all calculations is selected in the interval 1...1440 min.



#### Temperature measurement

MULTICAL® 602 is available in different versions for either Pt100 or Pt500 sensors as well as in 2-wire and 4-wire versions.

The measuring circuit includes a high resolution analog/digital converter with a temperature range of 0.00...185.00 °C.

In addition to current temperatures for the energy calculation average temperatures on a yearly and monthly basis can also be displayed.

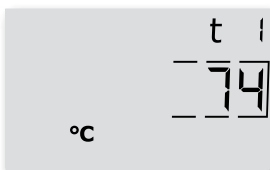
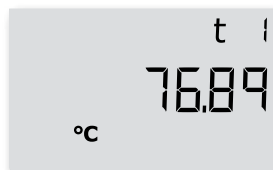

## MULTICAL® 602 DATA SHEET

### Calculator functions

#### Display functions

MULTICAL® 602 is equipped with a clear LC display including 8 digits, units of measurement and information panel. In connection with energy and volume readings 7 digits and the units of measurement to match are used, whereas 8 digits are used when e.g. meter number is read.

As a starting point the display shows accumulated energy. When the push buttons are activated the display reacts immediately by calling other readings. The display automatically returns to accumulated energy reading 4 minutes after the latest activation of the push buttons.

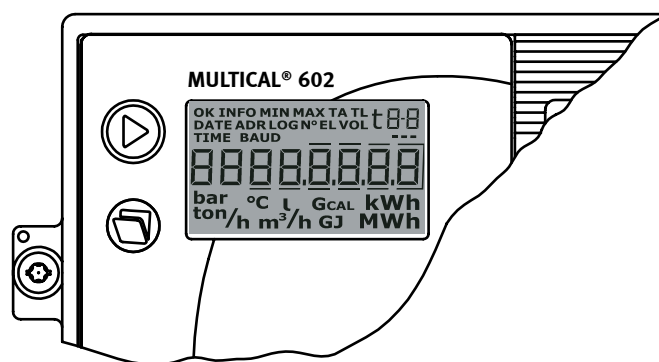

*The upper push button is used to switch between the primary readings. The consumers typically use the first primary readings in connection with self-reading for billing purposes.  
The lower push button is used to show secondary information on the selected primary reading.*

#### Set/reset function

The set/reset function of MULTICAL® 602 makes it possible to change a number of parameters by means of the two buttons on the meter's front.

The following parameters can be changed:

- Date
- Hour
- Input A (preset of register)
- Input B (preset of register)
- Meter no. of Input A
- Meter no. of Input B
- Pulse value for Input A
- Pulse value for Input B
- Primary M-Bus address
- Operating hour counter (reset)
- Info-event counter (reset)

As the installation seal is broken, the change can only be made by the energy supplier.

#### Reading Office

Cutbush Park, Danehill, Lower Earley,  
Reading, Berkshire. RG6 4UT. UK.  
Tel: +44 (0)118 9311188  
Email: info@able.co.uk

#### Aberdeen Office

Unit 6 Airside Business Park, Kirkhill Industrial Estate,  
Dyce, Aberdeen. AB21 0GT. UK.  
Tel: +44 (0)1224 725999  
Email: ab@able.co.uk

Internet: www.able.co.uk  
e-procurement: www.247able.com  
Registered in England No: 01851002  
VAT No: GB 417 2481 61



## MULTICAL<sup>®</sup> 602 DATA SHEET

### Calculator functions

#### Info codes

MULTICAL<sup>®</sup> 602 constantly monitors a number of important functions, e.g. power supply, temperature sensors and leakage alarms. Should a serious error occur in the measuring system or in the installation, a flashing “info” will appear in the display whilst the error exists. The “Info” panel will automatically disappear when the error has been corrected.

An info event logger indicates how many times the info code has been changed.

An error hour counter registers the hours during which the info code exceeds zero.

The info logger stores the latest 50 changes, of which 36 can be displayed.



Info code	Description	Response time
0	No irregularities	-
1	Supply voltage has been cut off	-
8	Temperature sensor T1 outside measuring range	1...10 min.
4	Temperature sensor T2 outside measuring range	1...10 min.
32	Temperature sensor T3 outside measuring range	1...10 min.
64	Leak in the cold-water system	1 day
256	Leak in the heating system	1 day
512	Burst in the heating system	120 sec.

Connecting ULTRAFLOW<sup>®</sup> 54 to MULTICAL<sup>®</sup> 602, 2-way communication is achieved between the flow meter and calculator and an additional set of info codes are available:

Info code	Description	Response time
16	Flow sensor V1, Data communication error	After 1 day (00:00)
1024	Flow sensor V2, Data communication error	After 1 day (00:00)
2048	Flow sensor V1, Wrong meter factor	After 1 day (00:00)
128	Flow sensor V2, Wrong meter factor	After 1 day (00:00)
4096	Flow sensor V1, Signal too low (Air)	After 1 day (00:00)
8192	Flow sensor V2, Signal too low (Air)	After 1 day (00:00)
16384	Flow sensor V1, Wrong flow direction	After 1 day (00:00)
32768	Flow sensor V2, Wrong flow direction	After 1 day (00:00)

## MULTICAL® 602 DATA SHEET

### Calculator functions

#### Data loggers

MULTICAL® 602 contains a permanent memory (EEPROM), where the results of a number of various data loggers are stored. The meter contains the following data loggers which can be read on the display or via serial data:

Data logging interval	Data logging depth	Logged value
Yearly logger	15 years	Counter registers (as seen on the display)
Monthly logger	36 months	Counter registers (as seen on the display)
Daily logger	460 days	Consumption (increase)/day
Hourly logger	1392 hours	Consumption (increase)/hour
Programmable data logger (option)	1080 loggings Logging interval 1-1440 min. (e.g. 45 days' hour loggings or 11 days' 15 min. loggings)	30 registers and values
Info logger	50 events	Info code, date, time and energy (E1/E2)

#### Leak surveillance

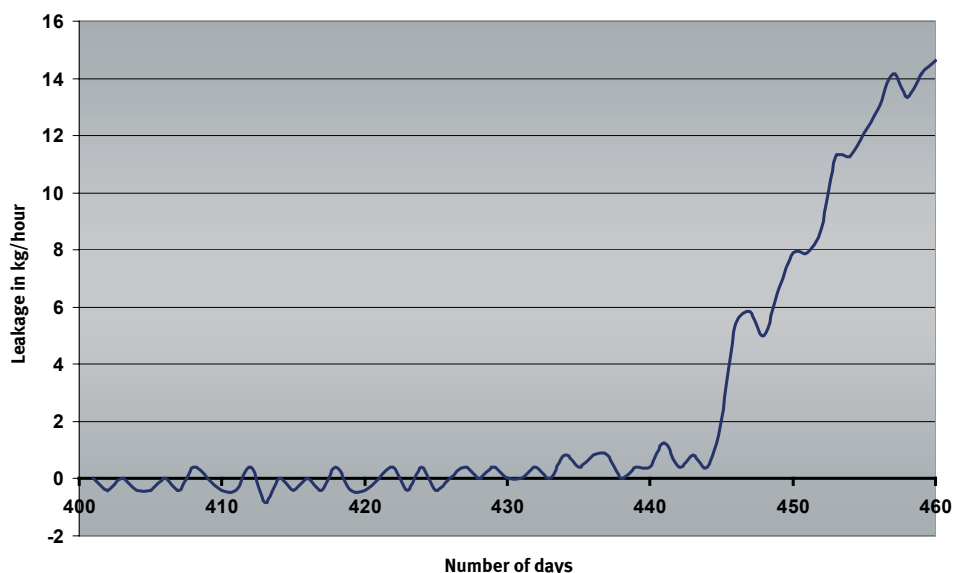

#### District heating systems

The leak surveillance system is primarily intended for direct connected district heating installations. The surveillance system consists of two water meters based on the ultrasonic principle, placed in inlet and outlet pipe respectively, and of temperature sensors in both pipes. MULTICAL® 602 monitors the mass difference that may appear between inlet and outlet pipe.

#### Cold-water systems

The pulse signal from the cold-water meter of the house can be connected to MULTICAL® 602. In this way it can monitor the cold-water consumption. A flushing toilet cistern, leaky heating coils in the water tanks or other leaks will cause that impulses from the cold-water meter are received 24 hours a day.



## MULTICAL® 602 DATA SHEET

### Calculator functions

#### Voltage supply

MULTICAL® 602 is available with battery supply, 230 VAC mains module, or 24 VAC mains module. The supply modules are exchangeable without breaking the verification seal.

#### Plug-in modules

Plug-in modules can be added to MULTICAL® 602 both in the calculator top (top modules) and in the base unit (base modules), in this way the meter can adapt to various applications and data reading methods. The modules can be seen in “Order specifications” on page 16.

#### Programming and verification

METER TOOL for MULTICAL® 602 is a Windows® -based software which includes all facilities for calculator programming. If the software is used together with VERIFICATION EQUIPMENT for MULTICAL® 602, the calculator can be tested and verified.

#### Tariff functions

MULTICAL® 602 has 2 extra registers TA2 and TA3 to accumulate energy parallelly to the main register based on a programmed tariff condition. No matter which tariff type you select the tariff registers will be displayed as TA2 and TA3.

The main register is always accumulated, irrespective of the selected tariff function, as it is considered the legal billing register. Tariff conditions TL2 and TL3 are monitored before each integration. If the tariff conditions are fulfilled, the consumed heat energy is accumulated in either TA2 or TA3, as well as the main register.



#### Reading Office

Cutbush Park, Danehill, Lower Earley,  
Reading, Berkshire. RG6 4UT. UK.  
Tel: +44 (0)118 9311188  
Email: info@able.co.uk

#### Aberdeen Office

Unit 6 Airside Business Park, Kirkhill Industrial Estate,  
Dyce, Aberdeen. AB21 0GT. UK.  
Tel: +44 (0)1224 725999  
Email: ab@able.co.uk

Internet: www.able.co.uk  
e-procurement: www.247able.com  
Registered in England No: 01851002  
VAT No: GB 417 2481 61



## MULTICAL® 602 DATA SHEET

### Pulse outputs and pulse inputs of the modules

#### Pulse outputs CE and CV

MULTICAL® 602 has pulse outputs for energy and volume pulses respectively. CE on terminals 16-17 releases one pulse per least significant digit of the energy count in the display and CV on terminals 18-19 releases one pulse per least significant digit of the volume count in the display.

If a higher resolution of pulse outputs is required, a CCC code with high resolution must be selected.



#### Pulse inputs VA and VB

MULTICAL® 602 has two extra pulse inputs, VA and VB, to collect and accumulate pulses remotely, e.g from cold-water meters and electricity meters. The pulse inputs are physically placed on the plug-in modules.

The pulse inputs VA and VB function independently of the other inputs/ outputs.



#### Reading Office

Cutbush Park, Danehill, Lower Earley,  
Reading, Berkshire. RG6 4UT. UK.  
Tel: +44 (0)118 9311188  
Email: info@able.co.uk

#### Aberdeen Office

Unit 6 Airside Business Park, Kirkhill Industrial Estate,  
Dyce, Aberdeen. AB21 0GT. UK.  
Tel: +44 (0)1224 725999  
Email: ab@able.co.uk

Internet: www.able.co.uk  
e-procurement: www.247able.com  
Registered in England No: 01851002  
VAT No: GB 417 2481 61



## MULTICAL<sup>®</sup> 602 DATA SHEET

### Cabinet design

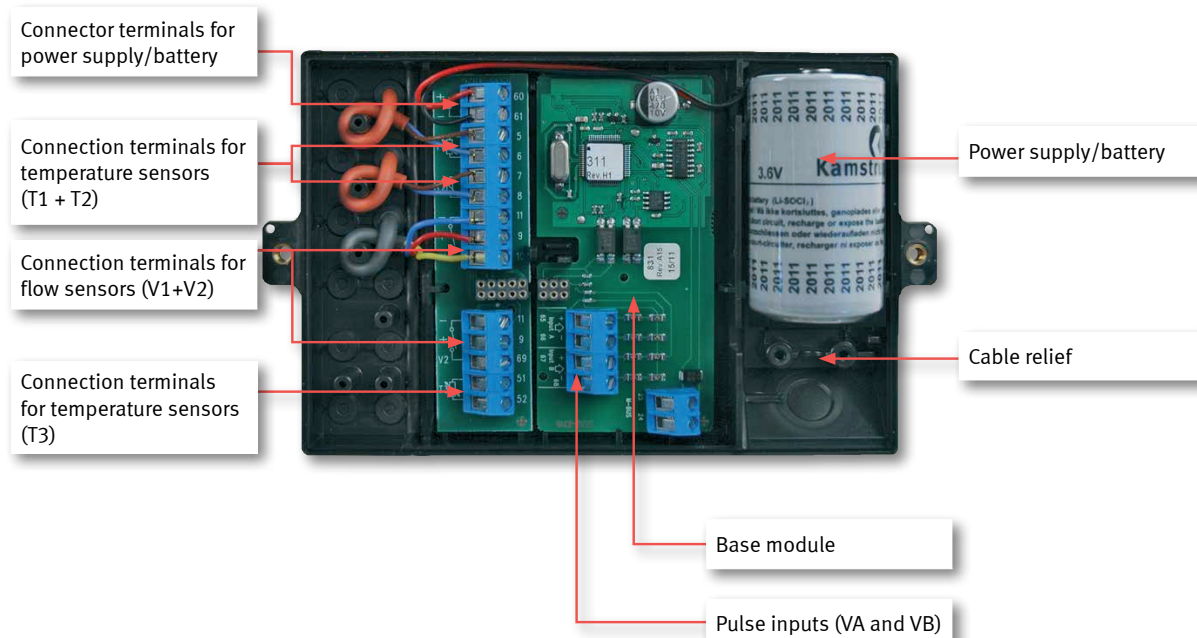
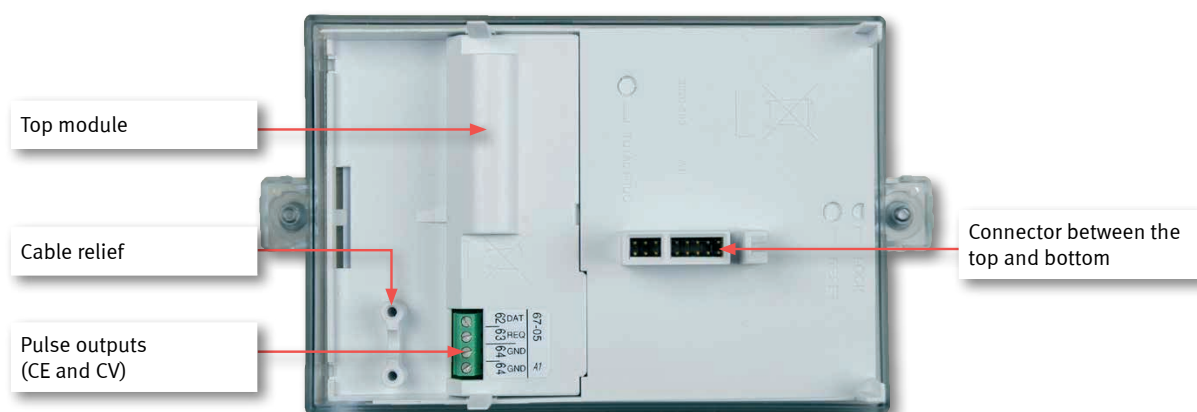

## MULTICAL<sup>®</sup> 602 DATA SHEET

### Approved meter data

Approval	Standard: EN 1434:2007, prEN 1434:2009 and OIML R75:2002
EU-directives	
– MID (Measuring Instruments Directive)	
– LVD (Low Voltage Directive)	
– EMC (Electromagnetic Compatibility Directive)	
Heat meter	
– Approval	DK-0200-MI004-020
– Temperature range	$\theta$ : 2 °C...180 °C
– Differential range	$\Delta\theta$ : 3 K...170 K
Cooling meter	
– Temperature range	$\theta$ : 2 °C...50 °C
– Differential range	$\Delta\theta$ : 3 K...40 K
Accuracy	$E_c \pm (0.5 + \Delta\theta_{\min}/\Delta\theta) \%$
Temperature sensors	
– Type 602-A	Pt100 EN 60 751, 2-wire connection
– Type 602-B+602-D	Pt500 EN 60 751, 4-wire connection
– Type 602-C	Pt500 EN 60 751, 2-wire connection
Flow sensor types	<ul style="list-style-type: none"> <li>– ULTRAFLOW<sup>®</sup></li> <li>– Electronic meters with active 24 V pulse output</li> <li>– Mechanical meters with electronic pick-up</li> <li>– Mechanical meters with reed switch</li> </ul>
Flow sensor sizes	
– [kWh]	$q_p$ 0.6 m <sup>3</sup> /h... $q_p$ 15 m <sup>3</sup> /h
– [MWh]	$q_p$ 0.6 m <sup>3</sup> /h... $q_p$ 1500 m <sup>3</sup> /h
– [GJ]	$q_p$ 0.6 m <sup>3</sup> /h... $q_p$ 3000 m <sup>3</sup> /h
EN 1434 designation	Environmental class A and C
MID designation	
– Mechanical environment	Class M1
– Electromagnetic environment	Class E1 and E2

The stated minimum temperatures apply to the type approval only. The meter has no cutoff for low temperature and thus measures as low temperatures as 0.01 °C and 0.01 K.

### Electrical data

#### Calculator data

Typical accuracy	
– Calculator	$E_c \pm (0.15 + 2/\Delta\theta) \%$
– Sensor set	$E_r \pm (0.4 + 4/\Delta\theta) \%$
Display	LCD – 7 (8) digits with a digit height of 7.6 mm
Resolution	9999.999 – 99999.99 – 999999.9 – 9999999
Energy units	MWh – kWh – GJ – Gcal

## MULTICAL<sup>®</sup> 602 DATA SHEET

### Electrical data

Data logger (Eeprom)	
– Standard	1392 hours, 460 days, 36 months, 15 years, 50 info codes
– Option	Data loggers with programmable interval
Clock/calendar	Clock, calendar, leap-year compensation, target date, Real time clock with battery back-up
Data communication	KMP protocol with CRC16 used for optical communication and for top and base modules
Power in temperature sensors	< 10 µW RMS
<b>Supply voltage</b>	3.6 VDC ± 0.1 VDC
<b>Battery</b>	3.65 VDC, D-cell lithium
Closed circuit	< 35 µA excluding flow sensor
Replacement interval	
– Mounted on wall	12 + 1 years @ $t_{BAT} < 30\text{ °C}$
– Mounted on flow sensor	10 years @ $t_{BAT} < 40\text{ °C}$
	The replacement interval is reduced when using data modules, frequent data communication or high ambient temperature.
<b>Mains supply</b>	230 VAC +15/-30 %, 50/60 Hz 24 VAC ± 50 %, 50/60 Hz
Insulation voltage	4 kV
Power supply	< 1 W
Backup supply	Integral super-cap eliminates operational stop-down due to shortterm power cuts (this only applies for supply modules type 602-0000-7 and 602-0000-8).
EMC data	Meets prEN 1434-4:2009 Class C (MID Class E2)
<b>Temperature measurement</b>	
Sensor inputs T1, T2, T3	
– Measuring range	0.00...185.00 °C
Temperature T3, T4	
– Preset range	0.01...180.00 °C
Max. cable lengths	
– Pt100, 2-wire	2 x 0.25 mm <sup>2</sup> : 2.5 m 2 x 0.50 mm <sup>2</sup> : 5 m
– Pt500, 2-wire	2 x 0.25 mm <sup>2</sup> : 10 m 2 x 0.50 mm <sup>2</sup> : 20 m
– Pt500, 4-wire	4 x 0.25 mm <sup>2</sup> : 100 m

## MULTICAL<sup>®</sup> 602 DATA SHEET

### Electrical data

Flow measuring V1 and V2	ULTRAFLOW <sup>®</sup> V1: 9-10-11 and V2: 9-69-11	Reed switches V1: 10-11 and V2: 69-11	24 V active pulses V1: 10B-11B and V2: 69B-79B
EN 1434 pulse class	IC	IB	(IA)
Pulse input	680 k $\Omega$ pull-up to 3.6 V	680 k $\Omega$ pull-up to 3.6 V	12 mA at 24 V
Pulse ON	< 0.4 V for > 0.5 msec.	< 0.4 V for > 100 msec.	< 4 V for > 3 msec.
Pulse OFF	> 2.5 V for > 10 msec.	> 2.5 V for > 100 msec.	> 12 V for > 10 msec.
Pulse frequency	< 128 Hz	< 1 Hz	< 128 Hz
Integration frequency	< 1 Hz	< 1 Hz	< 1 Hz
Electrical isolation	No	No	2 kV
Max. cable length	10 m	25 m	100 m

Pulse inputs <u>without</u> bounce damping VA and VB VA: 65-66 og VB: 67-68	Water meter connection FF(VA) and GG(VB) = 71...90	Electricity meter connection FF(VA) and GG(VB) = 50...60
Pulse input	680 k $\Omega$ pull-up to 3.6 V	680 k $\Omega$ pull-up to 3.6 V
Pulse ON	< 0.4 V for > 30 msec.	< 0.4 V for > 30 msec.
Pulse OFF	> 2.5 V for > 100 msec.	> 2.5 V for > 100 msec.
Pulse frequency	< 1 Hz	< 3 Hz
Electrical isolation	No	No
Max. cable length	25 m	25 m
Requirements to external contact	Leakage current at function open < 1 $\mu$ A	

Pulse inputs <u>with</u> bounce damping VA and VB VA: 65-66 and VB: 67-68	Water meter connection FF(VA) and GG(VB) = 01...40
Pulse input	680 k $\Omega$ pull-up to 3.6 V
Pulse ON	< 0.4 V for > 200 msec.
Pulse OFF	> 2.5 V for > 500 msec.
Pulse frequency	< 1 Hz
Electrical isolation	No
Max. cable length	25 m
Requirements to external contact	Leakage current at function open < 1 $\mu$ A

Pulse outputs CE and CV	Via top module 67-OB	Via top module 602-OC
Type	Opto FET	Open collector (OB)
Pulse length	Optional 32 msec. or 100 msec.	
External voltage	5...48 VDC/AC	5...30 VDC
Current	1...50 mA	1...10 mA
Residual voltage	$R_{ON} \leq 40 \Omega$	$U_{CE} \approx 1 V$ at 10 mA
Electrical isolation	2 kV	2 kV
Max. cable length	25 m	25 m

## MULTICAL<sup>®</sup> 602

### DATA SHEET

### Mechanical data

Environmental class	Meets EN 1434 Class A and C
Ambient temperature	5...55 °C non condensing, closed location (indoor installation)
Protection class	IP54
Storage temperature	-20...60 °C (drained flow meter)
Weight	0.4 kg excluding sensors and flow sensor
Connection cables	ø3.5...6 mm
Supply cable	ø5...10 mm

### Materials

Top cover	PC
Base unit	ABS with TPE gaskets (thermoplastic elastomer)
Print box	ABS
Wall bracket	Thermoplastic, PC 20 % GF

## MULTICAL® 602 DATA SHEET

### Order specifications

MULTICAL® 602	Type 602-								
<b>Sensor connection</b>									
Pt100	2-wire (T1-T2)	A							
Pt500	4-wire (T1-T2)	B							
Pt500	2-wire (T1-T2-T3)	C							
Pt500	4-wire (T1-T2) w/24 V pulse inputs	D							
<b>Top module</b>									
No module			0						
RTC + ΔEnergy calculation + hourly data logger			2						
RTC + PQ or Δt-limiter + hourly data logger			3						
RTC + data output + hourly data logger			5						
RTC + M-Bus			7						
RTC + ΔVolume + hourly data logger			9						
RTC + 2 pulse outputs for CE and CV + hourly data logger + scheduler			A						
RTC + 2 pulse outputs for CE and CV + prog. data logger			B						
2 pulse outputs CE and CV			C						
<b>Base module</b>									
No module			00						
Data + pulse inputs			10						
M-Bus + pulse inputs			20						
Radio Router + pulse inputs			21						
Prog. datalogger + RTC + 4...20 mA inputs + pulse inputs			22						
0/4...20 mA outputs			23						
LonWorks + pulse inputs			24						
Radio + pulse inputs (internal antenna) 434 or 444 MHz			25						
Radio + pulse inputs (external antenna connection) 434 or 444 MHz			26						
M-Bus module with alternative registers + pulse inputs			27						
M-Bus module with medium data package + pulse inputs			28						
M-Bus module with MC-III data package + pulse inputs			29						
Wireless M-Bus Mode C1 + pulse inputs			30						
Wireless M-Bus Mode C1 alternative registers + pulse inputs			35						
ZigBee 2.4 GHz int.ant. + pulse inputs			60						
Metasys N2 (RS485) + pulse inputs			62						
SIOX module (Auto detect Baud rate)			64						
BACnet MS/TP module			66						
GSM/GPRS (GSM6H)			80						
3G GSM/GPRS module (GSM8H)		Require High Power supply modules	81						
Ethernet/IP (IP201)			82						
High Power Radio Router + pulse inputs			84						
<b>Supply</b>									
No supply			0						
Battery, D-cell			2						
230 VAC High Power isolated SMPS			3						
24 VAC High Power isolated SMPS			4						
230 VAC isolated linear supply			7						
24 VAC isolated linear supply			8						
<b>Pt500 sensor set</b>									
No sensor set			00						
Pocket sensor set w/1.5 m cable			0A						
Pocket sensor set w/3.0 m cable			0B						
Pocket sensor set w/5 m cable			0C						
Pocket sensor set w/10 m cable			0D						
Short direct sensor set w/1.5 m cable			0F						
Short direct sensor set w/3.0 m cable			0G						
3 Pocket sensors in sets w/1.5 m cable			0L						
3 Short direct sensors in sets w/1.5 m cable			Q3						
<b>Flow sensor/pick-up unit</b>									
Supplied w/1 ULTRAFLOW®		(Please specify type)	1						
Supplied w/2 (identical) ULTRAFLOW®		(Please specify type)	2						
Prepared for 1 ULTRAFLOW®		(Please specify type)	7						
Prepared for 2 (identical) ULTRAFLOW®		(Please specify type)	8						
Prepared for meters w/electronic pulse output			K						
Prepared for meters w/reed switch output (both V1 and V2)			L						
Prepared for meters w/24 V active pulses			M						
<b>Meter type</b>									
Heat meter (MID module B + D)									2
Heat meter, closed systems									4
Cooling meter									5
Heat/cooling meter									6
Volume meter, hot water									7
Volume meter, cooling water									8
Energy meter, open systems									9
<b>Country code (language on label etc.)</b>									
									XX

When placing orders please state ULTRAFLOW® type numbers separately.

#### Reading Office

Cutbush Park, Danehill, Lower Earley,  
Reading, Berkshire. RG6 4UT. UK.  
Tel: +44 (0)118 9311188  
Email: info@able.co.uk

#### Aberdeen Office

Unit 6 Airside Business Park, Kirkhill Industrial Estate,  
Dyce, Aberdeen. AB21 0GT. UK.  
Tel: +44 (0)1224 725999  
Email: ab@able.co.uk

Internet: www.able.co.uk  
e-procurement: www.247able.com  
Registered in England No: 01851002  
VAT No: GB 417 2481 61





## MULTICAL<sup>®</sup> 602 DATA SHEET

### Tolerance band

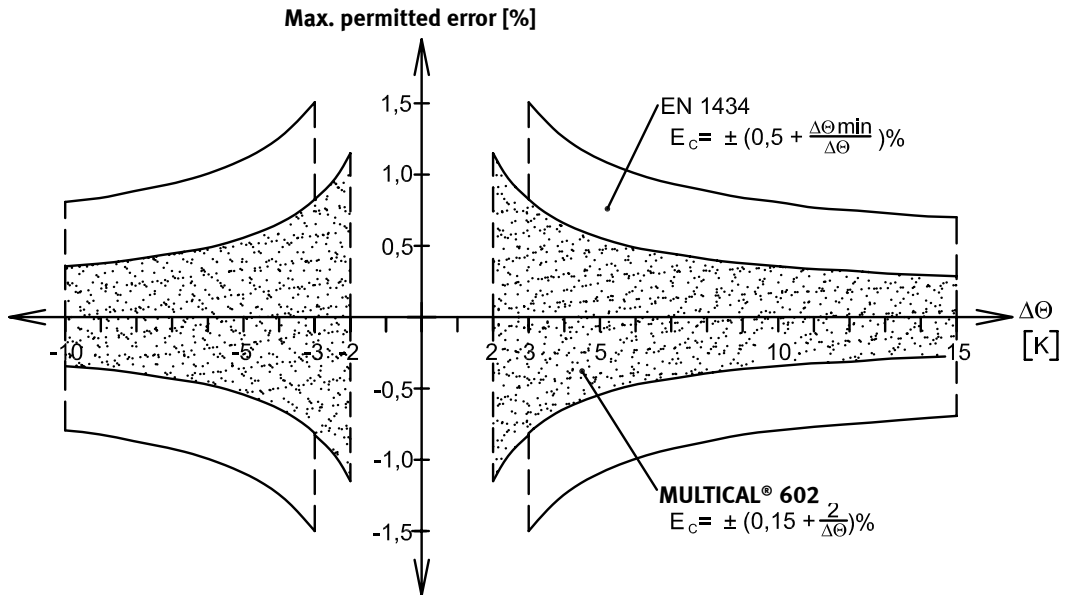

The above diagram shows the tolerance band of MULTICAL<sup>®</sup> 602 compared to the tolerance requirements of EN 1434.

#### Reading Office

Cutbush Park, Danehill, Lower Earley,  
Reading, Berkshire. RG6 4UT. UK.  
Tel: +44 (0)118 9311188  
Email: info@able.co.uk

#### Aberdeen Office

Unit 6 Airside Business Park, Kirkhill Industrial Estate,  
Dyce, Aberdeen. AB21 0GT. UK.  
Tel: +44 (0)1224 725999  
Email: ab@able.co.uk

Internet: [www.able.co.uk](http://www.able.co.uk)  
e-procurement: [www.247able.com](http://www.247able.com)  
Registered in England No: 01851002  
VAT No: GB 417 2481 61



## MULTICAL® 602

### DATA SHEET

### Dimentional sketches

MULTICAL® 602 mounted on ULTRAFLOW®

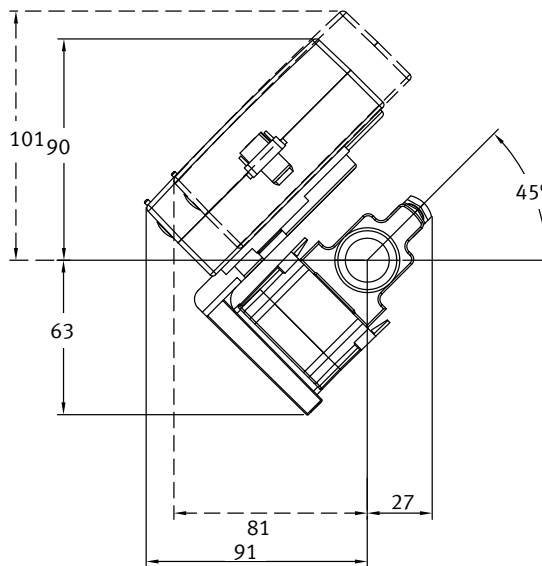

Front dimensions of MULTICAL® 602

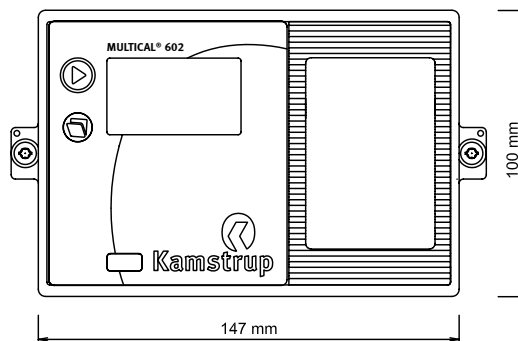

## MULTICAL® 602

### DATA SHEET

### Dimensional sketches

Wall-mounted MULTICAL® 602  
seen from the side

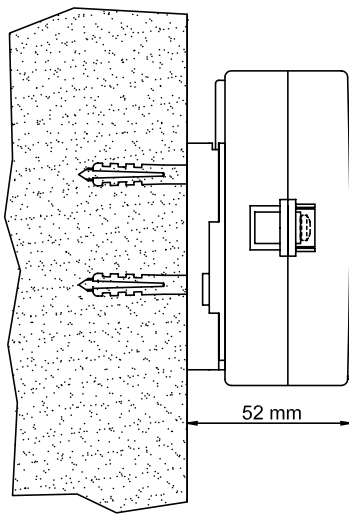

Panel-mounted MULTICAL® 602  
seen from the side

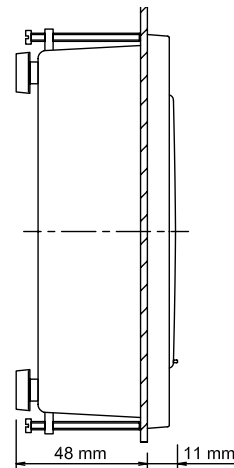

Panel mounted MULTICAL® 602 seen from the front

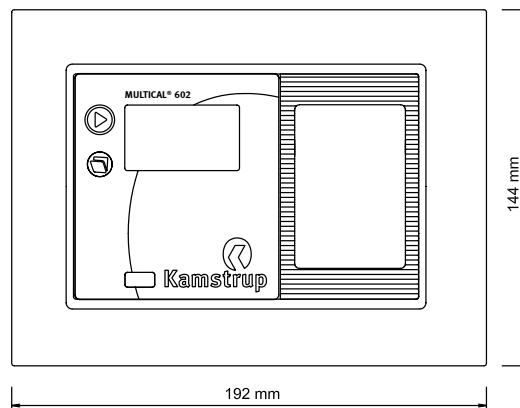

## MULTICAL® 602 DATA SHEET

### Accessories

Description	Type No.
D-cell battery	66-00-200-100
230 VAC High Power isolated SMPS	60200003000000
24 VAC High Power isolated SMPS	60200004000000
230 VAC isolated linear supply	60200007000000
24 VAC isolated linear supply	60200008000000
Pulse transmitter/divider for 602-A and 602-C	66-99-624
4-wire connection PCB with pulse inputs for 24 V active pulses (for 602-D)	66-99-614
Data cable w/USB plug	66-99-098
Infrared optical reading head w/USB plug	66-99-099
Infrared optical reading head w/D-sub 9F	66-99-102
Data cable RS232, D-sub 9F	66-99-106
Infrared optical reading head for Kamstrup/EVL w/USB plug	66-99-144
Verification unit (used with METERTOOL)	66-99-397/-398/-399
Temperature sensor set with connecting head (2/4 wired)	65-56-4x-xxx
External communication box	67-9x-xxxxx-2xx
METERTOOL for MULTICAL® 602	66-99-718
METERTOOL LogView for MULTICAL® 602	66-99-719

Please contact Kamstrup A/S for questions concerning further accessories.

#### Reading Office

Cutbush Park, Danehill, Lower Earley,  
Reading, Berkshire. RG6 4UT. UK.  
Tel: +44 (0)118 9311188  
Email: info@able.co.uk

#### Aberdeen Office

Unit 6 Airside Business Park, Kirkhill Industrial Estate,  
Dyce, Aberdeen. AB21 0GT. UK.  
Tel: +44 (0)1224 725999  
Email: ab@able.co.uk

Internet: www.able.co.uk  
e-procurement: www.247able.com  
Registered in England No: 01851002  
VAT No: GB 417 2481 61

